

An Introduction to the Dehydration and Drying of Fruits and Vegetables



Donald G. Mercer, Ph.D., P.Eng., FIAFoST
Department of Food Science
University of Guelph
Ontario, Canada

© November 2014

The material presented here has been copyrighted as a means of protecting this body of work. It is not my intention to impose any restrictions on the printing, copying, or distribution of this information. If you find any of the chapters useful for your drying activities, or if you would like to use anything for instructional purposes, please feel free to do so. A reference citing the source of any material which is reproduced would be greatly appreciated, whenever it is used.

As author, I assume no responsibility, nor liability, for any problems of any nature or manner which may be encountered through the application of the principles discussed here. Your drying equipment, starting materials, and individual applications will almost certainly impose conditions that will create unique situations. These cannot be anticipated in a general context such as that presented here.

© Donald G. Mercer

November 2014

ISBN 978-0-88955-621-8

To Our Grandchildren

Ethan, Mataya, and Keeleigh

An Introduction to the Dehydration and Drying of Fruits and Vegetables

Contents

Chapter Part 1: Food Drying Basics

1. Introduction
 - 1.1 Introduction
 - 1.2 Objectives

2. Reasons for Drying Fruits and Vegetables
 - 2.1 Introduction
 - 2.2 Defining the Terms “Dehydration and Drying”
 - 2.3 Prolonged Storage Life
 - 2.4 Weight Reduction
 - 2.5 Volume Reduction
 - 2.6 Taste and Texture
 - 2.7 Form Changes
 - 2.8 Convenience and Variety

3. Factors Influencing Food Quality
 - 3.1 Introduction
 - 3.2 Overall Appearance
 - 3.3 Feel
 - 3.4 Aroma
 - 3.5 Source
 - 3.6 Taste
 - 3.7 Variety
 - 3.8 Other Aspects

4. Initial Preparation Steps
 - 4.1 Introduction
 - 4.2 Inspection
 - 4.3 Washing
 - 4.4 Separation of Process Streams
 - 4.5 Worker Sanitation Practices

5. An Overview of the Drying Process
 - 5.1 Introduction
 - 5.2 The Drying Mechanism
 - 5.3 Factors Affecting Drying
 - 5.3.1 Properties of the Product
 - 5.3.1.1 Shape of the Material
 - 5.3.1.2 Size or Thickness of the Material
 - 5.3.1.3 Composition, Structure, and Porosity
 - 5.3.1.4 Initial Moisture Content
 - 5.3.1.5 Surface Characteristics
 - 5.3.1.6 Amount of Surface Available for Moisture Loss
 - 5.3.1.7 Seasonal Variation of Material
 - 5.3.1.8 Differences in Varieties of Material
 - 5.3.2 Dryer Properties
 - 5.3.2.1 Type of Dryer
 - 5.3.2.2 Dryer Design Features
 - 5.3.2.3 Air Temperature
 - 5.3.2.4 Time Spent in Dryer
 - 5.3.2.5 Relative Humidity of the Air Going into the Dryer
 - 5.3.2.6 Volumetric Air Flowrate
 - 5.3.2.7 Linear Air Velocity
 - 5.3.2.8 Air Flow Patterns and Uniformity of Air Flow
 - 5.3.2.9 Seasonal and Daily Variations in Weather and Air Conditions
 - 5.4 Effects of Drying on the Finished Product
 - 5.4.1 Nutritional Degradation
 - 5.4.2 Loss of Structural Integrity
 - 5.4.3 Reduction in Functionality
 - 5.4.4 Flavour and Aroma Changes
 - 5.4.5 Colour Changes
 - 5.4.6 Loss of Nutrients by Water Leaching
 - 5.4.7 Case Hardening

6. Some Key Aspects of the Drying Process
 - 6.1 Introduction
 - 6.2 Basic Design of a Forced-Air Dryer
 - 6.3 The Role of Air Temperature
 - 6.4 The Role of Air Velocity
 - 6.5 The Effect of Thickness on Drying
 - 6.6 The Effects of Surface Characteristics on Drying
 - 6.7 The Bottom Line

7. Basic Drying-Related Calculations
 - 7.1 Introduction
 - 7.2 Ways of Expressing Moisture Content
 - 7.2.1 Wet Basis Moisture
 - 7.2.2 Dry Basis Moisture
 - 7.3 Converting from Wet Basis to Dry Basis Moisture
 - 7.4 Converting from Dry Basis to Wet Basis Moisture
 - 7.5 Comparing Wet Basis and Dry Basis Moistures
 - 7.6 Calculating the Amount of Water and Solids that are Present
 - 7.7 Calculating the Amount of Water to be Removed
 - 7.8 Calculating the Amount of Starting Material to Give a Desired Amount of Product
 - 7.9 Calculating the Amount of Starting Material to Give a Desired Amount of Product When There is a Loss of Solids in the Drying Process
 - 7.10 Practice Problems (with answers)

 8. Advanced Drying-Related Calculations
 - 8.1 Introduction
 - 8.2 Water Removal Capacity of Dryers
 - 8.3 Calculating Dryer Feed Rates Based on Water Removal Capacities
 - 8.4 Calculations of Product Moisture Content When Exceeding Water Removal Capacity of a Dryer
 - 8.5 The Impact of Changing Raw Material Moisture on Final Product Moisture Levels
 - 8.6 Water Removal Rate Calculations Based on Experimental Results

 9. Dryer Design and Operation
 - 9.1 Introduction
 - 9.2 Direct and Indirect Heating
 - 9.3 Batch and Continuous Dryers
 - 9.4 Airflow in Dryers
 - 9.5 Types of Dryers
 - 9.5.1 Continuous Through-Circulation Dryers
 - 9.5.2 Tunnel Dryers
 - 9.5.3 Cabinet Dryers
 - 9.5.4 Tray Dryers
 - 9.5.5 Fluidized Bed Dryers
 - 9.5.6 Vibrating Bed Dryers
 - 9.5.7 Spray Dryers
 - 9.5.8 Drum Dryers
 - 9.5.9 Other Types of Traditional Dryers
 - 9.6 Emerging Technologies
-

10. Uniformity in Dryer Operation

- 10.1 Introduction
- 10.2 Creating a Uniform Product Bed
- 10.3 Creating Uniform Air Flow
- 10.4 Volume of Air to the Dryer
- 10.5 Assessing Dryer Performance
 - 10.5.1 Drying Uniformity
 - 10.5.2 Aspects to Consider
- 10.6 Assessing Uniformity
 - 10.6.1 An Approach to Water Removal Capacity and Drying Uniformity Determination
 - 10.6.2 Summary of Points for Water Removal Capacity Determination
 - 10.6.3 Typical Problems
- 10.7 Changes in Moisture After Drying
- 10.8 Controlling Drying Processes
 - 10.8.1 Basic Approach to Process Control
 - 10.8.2 Feed Forward and Feed Back Control
- 10.9 Factors to Remember About Product Drying

11. Drying Kinetics of Fruits and Vegetables

- 11.1 Introduction
- 11.2 Basic Drying Kinetics
- 11.3 Using Drying Kinetics
- 11.4 Comparing Drying Kinetics
- 11.5 Curve Fitting Difficulties
- 11.6 Creating and Using Moisture Ratio Mathematical Equations

12. Using Dried Fruits and Vegetables

- 12.1 Introduction
- 12.2 Rehydration – Definition
- 12.3 Dried Foods as Snacks
- 12.4 Dried Foods in Cooking
- 12.5 Rehydration of Dried Foods
- 12.6 Recipes Using Dried Ingredients

Part 2: Drying of Specific Fruits and Vegetables

- Introduction
- Apple Rings
- Bananas
- Beets
- Cantaloupe
- Carrot
- Cassava
- Celery
- Eggplant
- Ginger Root
- Herbs
- Jalapeno Peppers
- Mangoes
- Papaya
- Pineapple
- Pitaya
- Plantain
- Radishes
- Scotch Bonnet Peppers
- Star Fruit
- Sweet Green Peppers
- Taro
- Tomatoes
- Watermelon
- Yams
- Yellow Peppers (Hot)

Preface:

Food dehydration and drying has always been fascinating to me. After graduating from university, my first job in industry soon found me working with large industrial scale dryers for several years. Twenty years later, the opportunity to pursue food drying presented itself once again – this time in an entirely different context.

In 2002, I was part of a team examining ways to decrease the reliance on imported foods in Malabo on the island of Bioko in Equatorial Guinea. Solar drying was viewed as one potential solution to the spoilage of fruits and vegetables after harvesting. A series of drying trials was conducted on a second trip to Malabo later that year using a prototype solar dryer.

In 2003, a similar project in Honduras was directed to assessing the use of solar drying in the Catacamas area.

The role of drying in post-harvest preservation of food products became even more obvious with additional experience.

In August 2008, I had the privilege of spending three weeks on an assignment in Malawi. It was absolutely amazing and upsetting to see the number of mangoes that fell from the trees and literally rotted on the ground due to a lack of markets and extremely low prices for this common commodity. This seemed like an ideal opportunity to use drying technology as a way of preserving at least some of the mangoes and turning them into a potentially viable commercial venture. Once back in Canada, I began looking

at the kinetics of mango drying in the lab; and then built a small pilot-scale forced-air dryer to investigate the situation further. This ultimately led to a return visit to Malawi in February 2010 when we built a larger dryer at Bunda College in Lilongwe. Initial trials showed that the unit was suitable for mango drying and its potential application for the drying of other crops such as “pumpkins” (i.e., squash) was later demonstrated.

Further to these experiences, I have worked with the International Union of Food Science and Technology (IUFoST) to set up courses on drying for food industry workers in sub-Saharan Africa. This has led to the offering of a number of distance education format courses being offered through local mentors in at least seven sub-Saharan countries.

From 2010 to 2013, we worked with Kihonda College in Morogoro, Tanzania to set up courses on food preservation techniques, including drying, in an effort to enhance their training capacity. This work was sponsored by the Association of Canadian Community Colleges (ACCC) and the Canadian International Development Agency (CIDA).

In December 2013, the Canadian office of the Inter-American Institute for Cooperation on Agriculture (IICA) accepted our proposal for the “Development of a Strategy to Promote the Uptake of Food Dehydration and Drying Technology as a Means of Enhancing Food Preservation within the Caribbean Community (CARICOM)”. Once again, this shows the importance of food dehydration and drying.

It has also been my pleasure to instruct courses related to food drying within the Department of Food Science at the University of Guelph, and at Kemptville College, near Ottawa, Ontario.

During these years of working on food dehydration and drying, one simple fact has become increasingly obvious. It seems that drying is viewed as something that can be easily done with little or no training; and often without a basic understanding of the concepts involved. Frequently, difficulties are encountered in the drying process due to incorrect methods being used. Poor quality product may be obtained that can pose potential risks to the consumer, or which can cause spoilage during storage.

The purpose of this work is to provide those interested in drying fruits and vegetables with an introduction to what is really a very diverse topic. It is my preference to write in an informal narrative style using examples based on personal experiences, without the inclusion of academic citations.

Mathematics has a key role in understanding food drying. It is the basis for expressing a variety of aspects associated with drying from the rate at which moisture is removed from a product, to assessing the performance of a dryer. Every effort has been taken to provide detailed examples of the calculations that may be encountered. It should be noted that most of these are not especially complicated, but they may be somewhat intimidating to those with a fundamental fear of mathematics. From a rather simplistic perspective, drying can be viewed as involving only two basic components – water and solids.

Essentially, we need to follow the weights of water and solids throughout the drying process, through what is commonly referred to as a “mass balance” approach. Applying a series of appropriate calculations will allow us to do this.

As stated above, the examples are based on personal experiences. “Examples” and “Case Studies” have been modified to avoid infringement on any proprietary information, while still maintaining their relevance to real-life situations. Such “Examples” and “Case Studies” are intended for instructional purposes only. It should also be noted that all laboratory experiments were conducted personally using fruits and vegetables available at local supermarkets. Produce can vary depending on the geographical region and growing conditions. Your results may differ from those obtained here.

This material has been copyrighted as a means of protecting this body of work. It is not my intention to impose any restrictions on the printing, copying, or distribution of this information. If you find any of the chapters useful for your drying activities, or if you would like to use anything for instructional purposes, please feel free to do so. A reference citing the source of any material which is reproduced would be appreciated, whenever it is used.

As author, I assume no responsibility, nor liability, for any problems of any nature or manner which may be encountered through the application of the principles discussed here. Your drying equipment, starting materials, and individual applications will almost certainly impose conditions that will

create unique situations. These cannot be anticipated in a general context such as that presented here.

I am indebted to Mrs. Hazel Roberts, Head of the Hospitality Program at St. Vincent and the Grenadines Community College, for providing a variety of recipes to demonstrate the differences between working with fresh and dried ingredients. These welcome additions to Chapter 12 provide examples of using dried food products in “real-life” situations.

Finally, we must never forget the support of our family members. The patience and understanding of my wife, Jane, has helped to make this all possible. She’s the one who put up with my long days in the lab, going into work on weekends, and doing “number crunching” in the evenings for the mathematical modelling activities - not to mention building dryers in our garage.

I would also like to acknowledge our other family members: our son Darren and his wife Karren (yes, I know, they rhyme!); our son Geoffrey; and our daughters Andrea and Destiny.

There are three very special family members to whom I wish to dedicate this work - our three grandchildren; Ethan, Mataya, and Keeleigh. Of all the important things in this world, there is none so important as family.

I would like to recognize my parents, Audrey and Tom Mercer, who have always been so supportive in all of my endeavours.

It is my sincere hope that you find the information presented here useful for your particular needs and applications, and I wish you every success in your drying activities.

Sincerely,

Donald G. Mercer, Ph.D., P.Eng., FIAFoST
November 2014.

PART 1

Food Drying Basics

An Introduction to the Dehydration and Drying of Fruits and Vegetables

**Donald G. Mercer, Ph.D., P.Eng., FIAFoST
Department of Food Science
University of Guelph
Ontario, Canada**

1.1 Introduction:

To anyone who produces fruit or vegetables on a commercial basis, one of the most serious challenges is getting their produce to market and selling it before it spoils. It is an unfortunate fact of life that as soon as fruits or vegetables reach the proper stage of maturity, they begin to deteriorate. This can happen even before they are harvested.

Once the deterioration of fruits and vegetables begins, it is impossible to recover many of the attributes that were originally present.

Just as processors face the challenges of delivering their products to the marketplace, consumers also face the dilemma of purchasing produce that meets their expectations for quality and safety.

An added complication to selling produce is the fierce competition from other growers whose crops have also matured at the same time. This abundance of supply reduces prices and significantly diminishes the potential profits which would otherwise be possible. Within several weeks, supplies usually begin to dwindle as the harvest period ends. This often results

in the need to import fresh produce from other countries which creates higher prices for local consumers and diverts currency from domestic markets to foreign companies. A dependency on imported food products can have a serious negative impact on the balance of trade within a country and reduce its overall gross domestic product.

Not only does an abundance of a particular food reduce sales, but sellers must frequently get rid of unsellable product. Additional costs associated with disposing of spoiled material can add to the already disastrous impact of poor sales revenue.

Extending the useful life of various fruits and vegetables would ensure their availability for a longer period of time. There are several methods of post-harvest processing available to assist in this regard. One reasonably convenient way to increase the "shelf-life" of various fruits and vegetables is by drying them. With proper storage and handling, dried food products can be enjoyed several months after freshly grown local produce has disappeared from the local markets.

1.2 Objectives:

The information that is presented here is intended to provide basic instruction for the drying of fruits and vegetables that are commonly grown within tropical regions. Emphasis has been placed on crops found within the Caribbean Community (CARICOM).

We will examine the various aspects involved in the entire drying process from the selection of the proper materials for drying, through the actual drying process, to the storage and handling of the dried product for sale.

It should be noted that a certain degree of consumer education may be necessary in order to familiarize those unaccustomed to using dried food products with the differences between dried and fresh material.

While this is not intended to be a “drying course”, the material contained here is aimed at providing the reader with sufficient insight into the subject so that he or she is able to:

- Select appropriate starting materials for the drying process.
- Prepare a variety of fruits and vegetables for the actual drying process to ensure optimal drying rates.
- Establish conditions necessary for the optimal drying of various products.
- Identify potential problems that may result due to improper drying procedures and be able to take appropriate measures to avoid them.
- Perform mathematical calculations associated with food dehydration and drying.
- Plan and conduct basic trials to identify procedures suitable for drying fruits and vegetables.
- Transfer knowledge gained from the drying of one particular product to the drying of a similar product that you have not previously attempted to dry.
- Gather and interpret data from the drying of various products to explain the drying mechanisms that are taking place, as well as determining the rate of water removal at any time during the drying process.
- Handle and store dried food products in a manner that will provide the maximum storage life.

2. Reasons for Drying Fruits and Vegetables:

2.1 Introduction:

Before proceeding to the actual science of food dehydration and drying, it is probably best to understand what is meant by “dehydration and drying”, and the reasons why this is done.

2.2 Defining the Terms “Dehydration and Drying”:

The Encarta Dictionary available with the Microsoft Word program defines dehydration as being used in the food industry to describe “the removal of moisture from food as a way of preserving it”. In more general terms, we may refer to the removal of moisture from any material as a “drying” process.

In the context of this work, we shall use the term “drying” to refer to the removal of water from food products and will assume it to be essentially the same as “dehydration”. In this way, any unnecessary confusion can be avoided.

2.3 Prolonged Storage Life:

By far, the vast majority of the fruits and vegetables we eat contain more moisture (i.e., water) than any other single component. For example, the fleshy part of a mango contains approximately 85% water by weight. Sweet and hot peppers contain about 93% to 95% water by weight. Tomatoes may contain 95% water on a weight basis.

Taking a closer look:

This means that 100 kg of mangoes with 85% moisture by weight will contain 85 kg of water. The remaining 15 kg will be composed of “solids” which are predominantly natural sugars, as well as connective fibrous material.

100 kg of peppers with 93% moisture would contain 93 kg of water and 7 kg of solids.

100 kg of tomatoes with 95% moisture would contain 95 kg of water and only 5 kg of solid material in its flesh.

In Figure 2-1, we see a hot yellow pepper that weighs 56.4 grams. Since 93.8% of its weight is water, there will be about 52.9 grams of water and only 3.5 grams of solid material.

**Chapter 2:
An Introduction to the Dehydration and
Drying of Fruits and Vegetables**

**Donald G. Mercer, Ph.D., P.Eng., FIAFoST
Department of Food Science
University of Guelph
Ontario, Canada
ISBN 978-0-88955-621-8
© 2014**



Figure 2-1: A hot yellow pepper weighing 56.4 grams

Figure 2-2 shows just how much water there actually is in this hot yellow pepper. Here, we have placed 52.9 grams of water in a beaker. A bit of green food colouring has been added to make the water more visible in the photo. When you take time to think about it, it is rather amazing how much water is present in the foods we eat.



Figure 2-2: There are 52.9 grams of water in the hot yellow pepper shown in Figure 2-1

We can do a similar calculation for a mango. The mango in Figure 2-3 weighs 353 grams and has a moisture content of 85.0%. On this basis, there will be 300 grams of water and only 53 grams of solids. The beaker beside the

mango contains 300 mL of water which weigh 300 grams.



Figure 2-3: There are 300 grams of water in this mango which weighs 353 grams

Within the ripe fleshy portion of the mango, there is a considerable amount of naturally occurring sugar. It is the sugar which gives the mango its appealing sweetness. The juice of the mango is composed of sugar dissolved in water inside the fleshy portion of the fruit. There are other compounds present which provide the distinctive flavour and aroma.

Unfortunately, the juice of the mangoes is also a convenient source of nutrients for microorganisms like molds. Once molds or other microorganisms begin to grow, they will make the flesh of the mangoes unfit for human consumption.

Looking at Figure 2.4, we can see how unappetizing a moldy slice of mango appears. The black spots are mold colonies. Some of these have developed to the stage where they have produced a grey fuzzy covering.



Figure 2-4: A moldy slice of mango

If we remove most of the water from the mangoes, there will no longer be enough moisture present to support the growth of microorganisms. As a result, the mangoes will not spoil as rapidly as they would if the water was present. This means that we will have a “shelf-stable” product that can be kept for several months without spoiling. Even though most of the water has been removed, the dried flesh of the mango will retain most of its nutritional properties.

An added advantage of increasing the shelf-life of fruits or vegetables through dehydration is that they can be shipped longer distances (possibly to foreign markets). During the considerable time it takes to reach far-off destinations, fresh produce could easily spoil. However, this problem can be avoided if dried products are exported.

2.4 Weight Reduction:

In addition to making fruits and vegetables last longer before they spoil, there are some additional reasons for drying them. By removing most of the water that was originally present, we are left with only the solids and a small amount of water. This makes a very large difference between the weight of the fresh mangoes and those that have been dried.

A benefit of the weight reduction is that dried products can be shipped at a lower cost since there is no need to transport large amounts of water. For example: 100 kg of fresh peppers with a moisture content of 93% by weight can be dried to give about 7.8 kg of dried pepper slices. This includes the 7.0 kg of solids plus 0.8 kg of water that is left in the dried slices. As a result, we can ship only the solids portion of the peppers and a small amount of water, thereby avoiding the expense of having to transport the added weight of the 92.2 kg of water that was removed.

2.5 Volume Reduction:

Removing the water from fleshy produce such as Scotch Bonnet peppers causes them to shrink in size. Therefore, the dried peppers take less volume to store or transport than their fresh counterparts. Figures 2-5a and 2-5b show Scotch Bonnet pepper slices before and after drying. Hopefully, you can see the differences in their appearance and size.



Figure 2-5a: Scotch Bonnet pepper slices before drying



Figure 2-5b: Scotch Bonnet pepper slices after drying

2.6 Taste and Texture:

Taste and texture are two other things to consider when comparing fresh and dried produce. This is especially true in regard to sweet fleshy fruits and berries. When water is removed from them, the sugars that were dissolved in their juice remain in the dried flesh. This means that the dried slices of fruit or the dried berries will contain a high concentration of natural sugars and will have a very pleasant sweet taste with a somewhat stronger flavour than the fresh “wet”

fruit. Drying also tends to make the flesh take on a leathery texture which creates a pleasant chewy snack.

The overall change in moisture content, volume, and sweetness can have an effect on the consumption of these snacks. Care must be taken not to over-indulge in eating dried products, and water consumption should be monitored to compensate for the reduced moisture in the snacks.

For those who are conscious of their sugar intake, a few slices of dried fruit may contain as much sugar as eating an entire fresh fruit such as a mango.

Let's consider 100 grams of fresh mango slices. If the moisture content is 85% by weight, there will be 85 grams of water present. Of the remaining 15 grams of solids, approximately 13 grams are sugars. If we dry 100 grams of fresh mangoes to a final moisture content of 10% by weight, we will have approximately 16.7 grams of dried product. 13 grams of this will be sugars present in the original 100 grams of fresh mangoes.

A person needs to eat only 50 grams of dried mango slices to obtain the same amount of sugar that would be present in 300 grams of fresh mango slices.

We will explain these calculations in a later section.

2.7 Form Changes:

When some fruits and berries are dried, the final product has such a significant change in properties from the initial material that their dried form is given an entirely different name. Dried grapes become raisins, and dried plums become prunes.

Figure 2-6 shows fresh grapes and raisins. Note the difference in size and appearance between these two forms. Texturally, the grapes are plump and juicy. They are very soft and fleshy once the outer skin is broken by biting into them. In comparison, the raisins have a more leathery texture and are much chewier. However, they also taste sweeter than a fresh grape from which they are derived.



Figure 2-6: Fresh grapes and sun-dried raisins

Figure 2-7 shows a fresh plum and the prunes which result when moisture is removed from them by drying.



Figure 2-7: Fresh plum and prunes obtained from drying

2.8 Convenience and Variety:

Fruits and vegetables may also be dried as a manner of increasing their convenience for later use, or to add variety to our diets.

Even though grapes and raisins are obtained from the same basic starting material, they offer quite different alternatives to the way in which they are consumed. Fresh grapes are generally eaten “as is” with little or no further modification. In comparison, raisins may be used in a much wider range of products such as an ingredient in baked goods, or as a convenient, natural, and nutritious snack requiring little or no clean-up.

We may also want to consider the drying of cereal grains and pasta products.

Rice may be fully cooked and dried in order to “instantize” it. Drying is done in such a way that the structure of the plump rice kernel is maintained, but the water is removed from the cooked starchy material. The dried rice kernels can then be mixed with boiling water

and allowed to soak for several minutes, after which they are ready to be eaten.

Various noodle products are sold as convenience foods for making quick meals. Often, the noodles are packaged in a disposable cup with added spices or seasoning. The user then opens the sealed cup, pours in an appropriate amount of boiling water, stirs the mixture, and then has a ready-to-eat meal.

Figures 2-8a through 2-8c show a dried noodle product at various stages in its preparation for eating. In the first photograph (Figure 2-8a), we see the dried noodles and vegetables in a plastic bowl in which they will be re-hydrated with boiling water



Figure 2-8a: Dried noodle product before the addition of water.

Figure 2-8b shows the seasoning mix on top of the dried noodles.



Figure 2-8b: The dried noodle product with the seasoning mix sprinkled over the noodles.

After water is added to bring the level to the indicated line on the plastic bowl, the mixture is stirred and allowed to stand until the noodles have become completely hydrated and softened. The result is a pasta meal that is ready to eat in only a few minutes with very little effort to prepare (Figure 2-8c).



Figure 2-8c: Rehydrated noodles and seasonings after the addition of boiling water and adequate stirring.

3. Factors Influencing Product Quality

3.1 Introduction:

The importance of selecting the proper starting materials for drying is often overlooked. Only the best quality produce available should be used. Any processing facilities that are drying fruits or vegetables should have a set of standards in place to define the quality of their ideal starting material. Since this is very subjective, we cannot set out any actual standards here. We can, however, look at some of the basic attributes which need to be considered.

We will examine factors influencing the quality of the finished product during the actual drying process in subsequent sections of this manual. Right now, our main focus will be the quality of the starting materials.

All starting materials need to pass a visual inspection before they can be given any additional consideration. In general, they should be free from blemishes such as bruises and insect damage. They may need to be of a certain size or weight to make handling easier. Colour may assist in determining the desired degree of ripeness. As many fruits and berries ripen, their sweetness increases and their texture changes. Both of these are important factors that can be partially assessed by a preliminary visual inspection.

If there is any surface contamination, such as visible mold growth or bird droppings, these fruits or berries and those within the same shipment should be seriously considered for rejection. While bird droppings can be removed by washing, it should be remembered that fecal matter carries with it a variety of microorganisms that can be the cause of potential food-borne illnesses.

Vegetables need to be free from dirt and thoroughly washed. It should be remembered that there are many earth-borne contaminants that can cause serious problems if they are ingested. *Clostridium botulinum* spores can remain dormant in food products. Once they vegetate, they may produce toxins which can have serious health implications. Ensuring that the starting material is clean is only one of the steps necessary to prevent later problems of this nature.

Figures 3-1a and 3-1b show two mangoes purchased for drying trials. The mango in Figure 3-1b has a slightly

Chapter 3:
An Introduction to the Dehydration and Drying of Fruits and Vegetables

Donald G. Mercer, Ph.D., P.Eng., FIAFoST
Department of Food Science
University of Guelph
Ontario, Canada
ISBN 978-0-88955-621-8
© 2014

3.2 Overall appearance:

different colour than the one in Figure 3-1a even though it of is the same variety. This is due to the fact that it is slightly more ripe.



Figure 3-1a: Less ripe mango



Figure 3-1b: More ripe mango

Figure 3-2a shows three hot yellow peppers shortly after they have been harvested and shipped to international markets. The colour is a distinctive greenish yellow and the surface has a smooth waxy appearance that is free from blemishes.



Figure 3-2a: Hot yellow peppers shortly after harvesting

After being stored at room temperature for fourteen days, the colour has changed to a deep red. There is also a pronounced difference in the texture of their surface which is now wrinkled and dull in comparison to the original surface on the fresh peppers. While there may be no serious impact of these changes on the end use of the peppers, the impact of time is clearly demonstrated.



Figure 3-2b: Hot yellow peppers after several weeks of storage.

Eventually, these peppers can become cracked and leathery as they slowly lose some of their moisture in the room air.

3.3 Feel:

Starting materials being selected may need to have a certain degree of firmness that will indicate their level of ripeness or quality for drying. This will help verify the initial visual inspection. Fruits that are overly ripe, or too soft, may be hard to peel and slice. Their texture may not be suitable for processing. Fruit that is too firm may not have sufficient ripeness to have developed the correct level of sweetness. While they are easy to handle and may dry satisfactorily, the taste of the final dried product may not be as sweet as desired.

Feeling the starting material may also let you know how juicy it is. A certain level of moisture is necessary to provide a high quality product from the point of view of texture, flavour, and sweetness.

Vegetables such as carrots that are limp, or flaccid, cannot be expected to provide the same quality after drying as carrots that are firm and crisp. See Figures 3-3a and 3-3b.

A common error in drying is to use low quality starting material that could not otherwise be sold as fresh produce. The expectation is that drying will somehow mysteriously convert it into a high quality material once again. Sadly, this is not the case with most drying applications.



Figure 3-3a: Firm crisp carrots



Figure 3-3b: A carrot which has lost its crispness

3.4 Aroma:

It is often possible to pick the desired starting material by examining how it smells. Many fruits, such as mangoes, have a characteristic aroma that may help in assessing the quality of the starting material. In general, any fruit with an uncharacteristic or suspicious odour should be avoided, since it may be spoiled.

3.5 Source:

Any materials for drying and other processing should be bought from trusted suppliers. The fresh fruits and vegetables entering a processing facility can bring many problems with them. As a processor, you need to know the past history of your raw materials which you will ultimately be selling to your customers.

You need to know if chemicals were used during the growth period of the fruits or vegetables. Were they sprayed with insecticides or pesticides? Were any fertilizers used, and if so, were they appropriate? What were the general conditions under which the materials were grown? Are there any potential health risks imposed by the growing, harvesting, or storage and handling conditions? Fruits and vegetables purchased in the market may not have a good history of how they were grown, harvested, or handled (see Figure 3-4).



Figure 3-4: We have no idea how these mangoes in the market were handled

Another very important factor is the manner in which the starting materials were obtained. In the case of tree fruits, were they removed from the trees in a picking process, or were they picked up off the ground as “windfalls”?

The term “windfalls” refers to fruit that has ripened on the tree and has been knocked down by the wind. In other cases, it may simply be too heavy to be supported any longer by the stem which connects it to the tree.

Fruit that has fallen from the tree and been picked off the ground often has surface contamination. The causes of this contamination are often from being in contact with droppings of animals such as sheep, goats, or cattle that have been grazing in the areas around the trees. “Windfall” fruit should be avoided whenever possible.

3.6 Taste:

Since your dried fruits and vegetables will end up as a food product, it is a good idea to taste the starting material. Fruits and berries which are not sufficiently sweet or have an undesirable texture, or “mouth-feel”, should not be used. This is a difficult point to describe or define. However, some basic descriptions outlining examples of desirable flavour attributes can go a long way to assuring a higher quality finished product.

3.7 Variety:

Certain varieties of fruits such as mangoes or apples may have better properties for drying than others. Some mangoes are large and juicy with a high level of sweetness. Others may be smaller with a higher fibre content and lower sweetness level. There is also the need to understand which varieties will give you the best finished product to meet the needs of your customers. You may need to process a number of different varieties to satisfy the different preferences of the consumers.

Figure 3.5 shows three varieties of apples which are popular among consumers. They may have different drying properties due to textural differences and possibly due to such things as their moisture and sugar content.



Figure 3.5: Royal Gala, Granny Smith, and McIntosh apples

Royal Gala apples have a much softer texture than the Granny Smith apples which are noted for their firmness. The McIntosh apples have a characteristic “snap” when you bite into them, but are not as firm as the Granny Smiths.

In areas where only one variety of a particular fruit or vegetable is available, this factor will not be an issue.

3.8 Other Aspects:

The points listed above may not cover all aspects of the products you are drying. Before you begin drying a specific product, you should compile a list of all desirable attributes found in the fresh material. These attributes can then be incorporated into specifications for raw materials.

4. Initial Preparation Steps:

4.1 Introduction:

Once you have selected your starting materials, the basic preparation steps can begin. This is something that must be done before the actual drying process can get under way.

4.2 Inspection:

Even if the incoming starting material has been inspected at its point of purchase, it needs to be closely examined as it comes into the processing plant facility. This should be done before anything is unloaded from the delivery vehicle. Sub-standard material can then be easily diverted from the processing facility area. Had anything been unloaded prior to inspection, it would be necessary to reload it onto the delivery vehicle for removal from the plant, after which it would have to be disposed of in an appropriate and responsible manner.

Preliminary inspection also reduces the risks of spreading potential contaminants around the processing plant should any be found on the raw material.

All accepted raw material must be thoroughly washed before entering the main processing area. Outer surfaces can be contaminated with potentially dangerous micro-organisms from a variety of sources such as birds, insects, rodents, grazing animals (in the case of windfalls), the soil, and handling equipment in the harvesting and shipping processes.

There should be minimal delay between acceptance of the raw materials and the time they go through the initial washing phase of the process. This will reduce the need to store incoming fresh fruits or vegetables before washing and help maintain a clean production environment.

Washing must be done with potable water. "Potable water" is water that is fit for human consumption. This will prevent further contamination, which would be the case if impure water was used in the washing stage.

A rinse with a chlorine solution or passage through a bath of chlorine solution would help reduce the microbial population on the surface of the mangoes. The easiest way to prepare a disinfecting solution of chlorine is by using a bleach solution. A household bleach container often has instructions on the label for preparing such a solution.

The strengths of chlorine solutions can vary depending on their application and the concentration of the initial bleach solution. A mixture of 180 mL of bleach and 4 litres of potable water may be sufficient for this application. A thorough

Chapter 4:
An Introduction to the Dehydration and Drying of Fruits and Vegetables

Donald G. Mercer, Ph.D., P.Eng., FIAFoST
Department of Food Science
University of Guelph
Ontario, Canada
ISBN 978-0-88955-621-8
© 2014

4.3 Washing:

rinse with potable water would then remove any residual chlorine.

4.4 Separation of Process Streams:

There is always a risk of bringing undesirable microorganisms and other contaminants into a processing facility. To minimize this risk, there needs to be a means of ensuring separation between different areas. Raw material receiving areas must be separated from the rest of the processing facility. Workers should not be allowed to travel from one area to the other without safeguards being in place to prevent contamination of one area by materials and contaminants from another area. You may want to consider the receiving area as being “dirty” and have it totally isolated from the remainder of the processing plant.

Incoming materials that have been washed may be considered as being “clean”. They may need to be stored for a short period of time before going on to the next processing step. Holding times of the “clean” washed product should be minimized. The storage area must be closely monitored to ensure that the first materials to come into the “clean” storage area are the first ones to leave when additional fresh materials are brought in.

Remember: “FIFO” (First In → First Out)

From the “clean” storage area, washed fruit may need to go to a peeling operation. Here, the outer peel would be removed by using a paring knife, peeling device, or mechanical peeler.

4.5 Worker Sanitation Practices:

Because the inner surface of the fruit is now exposed, workers who are doing the peeling and other steps should be wearing proper attire for the job. Hairnets or other suitable head covering plus beard nets, if warranted, must also be worn. Coats, smocks, or similar uniforms, along with proper safety equipment (e.g., proper safety shoes or other footwear, gloves, knife guards, etc.) are absolutely essential. Light-coloured uniforms, especially white, are better than darker coloured uniforms for hygienic purposes since stains and spills are more easily recognized on the lighter-coloured fabric.

Your fingers are the ten most common causes of infection and food contamination

(Figure 4-1)



Figure 4-1: Your hands are a major contributor to the spread of infection and contamination.

Hand-washing stations using warm potable water and equipped with soap

dispensers should be within easy access of workers. Towels for hand-drying should be clean and changed regularly. In addition, there should be adequate washroom facilities which should be maintained and cleaned according to a regular schedule. Workers should never return to their work stations without having properly washed their hands.

Workers must wash their hands:

- before and after handling foods or eating
- after using washroom facilities
- after sneezing, coughing, or blowing their nose
- after touching a cut or open sore
- after being outside or touching any unclean surfaces

Proper hand-washing includes:

- wetting the hands with clean warm water
- applying soap
- rubbing the hands together to create a lather which is to be spread on the front and back of the hands, between the fingers, and under the fingernails.
- lathering should continue for at least 20 seconds
- once thoroughly lathered, the hands should be rinsed with warm potable water (i.e., water that is safe for drinking).
- a clean fresh towel should be used for drying the hands (paper towels are ideal for this purpose)
- the towel should be used to turn off the water faucet and then be discarded in a proper receptacle

Hand-washing is the most effective way to stop the spread of illness and disease

During peeling, workers will be using knives or peeling devices to remove the outer peel from the fruit. Sufficient safety training must be provided to each worker to prevent personal injuries and to impress upon them the importance of cleanliness within the processing facility.

WORKER SAFETY IS OUR #1 CONCERN

Workers with cuts or open sores should not be allowed in the production facility where there could be a potential threat to the cleanliness of the area.

Peels from the fruit must be removed from the area within a reasonable time period and not be allowed to accumulate. Peels may provide a risk of contamination even though they have been previously washed. Since they are biodegradable, they can be sent to a composting area. The peeled fruit should then be sliced for drying.

The condition of the knives and other utensils is important for worker safety. Blades should be kept sharp and free from rust, dirt, and other sources of contamination.

All surfaces should be washed with potable water and disinfected with a chlorine-in-water solution of suitable concentration after each production batch or shift. All equipment should be thoroughly cleaned according to

appropriate standards which are beyond the scope of this guide.

Figure 4-2 shows a dragon fruit (also known as pitaya or pitahaya) prior to being processed. The steps involved in preparing it for drying provide numerous opportunities for personal injury (cutting and slicing), as well as for contamination of the material during handling.



Figure 4-2: Dragon Fruit prior to processing

The dragon fruit is usually cut in half lengthwise to remove the fleshy portion which can then be sliced for drying (see Figure 4-3).

Any of the waste material from the peeling stages must be taken from the processing area and disposed of in a responsible manner. Some processors have procedures in place where suitable organic wastes are converted to a usable by-product in the form of compost.



Figure 4-3: Fleshy portion of dragon fruit awaiting slicing before drying

5. An Overview of the Drying Process

5.1 Introduction:

Before we go too far into the details about drying, we need to look at how moisture is removed during a typical drying process. The concepts applied here will be applicable to the majority of other materials that we encounter in our drying work. Rather than trying to discuss everything in totally general terms, it might be easier to use some specific examples like apples or hot yellow peppers.

5.2 The Drying Mechanism

Most products dry because moisture (which is really water) is removed from their surfaces. If we have a sliced apple, we can see that the surface tends to be wet - especially if the apple is ripe and juicy.

It is important that the air used for drying purposes is not overly humid, or saturated with moisture. When warm dry air is blown across the surface of the wet apple slices, it picks up some of the moisture by the process of evaporation. Evaporation is the change that occurs when water goes from being a liquid to a vapour. So, the warm air now contains water vapour and carries it out of the dryer and away from the slices of apple.

As more and more air blows across its surface, moisture from inside the apple slices comes to the surface to replace the moisture that was lost. We call this process of moisture moving from the centre of the material to the outer surface “diffusion”. Moisture that has diffused to the surface is then evaporated and swept away by the moving air.

At the start of the drying process, the combination of a wet surface and additional moisture coming to the surface makes the rate at which the water is removed quite high. Figure 5-1 shows how the drying process occurs when the moist apple slices are first placed in the dryer. The surface is considered to be saturated with moisture which is like having a “pool” of moisture there from which evaporation can take place. Moisture evaporates from the “pool” at a uniform or constant rate.

Eventually, a point will be reached where the surface no longer looks wet, since there is no visible moisture present. Moisture will still be travelling from the centre of the slice to the surface, but it will be removed as soon as it gets there. As more and more moisture is removed, the rate of water removal gets slower and slower.

In Figure 5-2, we can see that there is no pool of moisture on the surface of the apple slice. Slow diffusion of moisture to the surface has become the only way in which moisture can be removed.

Chapter 5:
An Introduction to the Dehydration and Drying of Fruits and Vegetables

Donald G. Mercer, Ph.D., P.Eng., FIAFoST
Department of Food Science
University of Guelph
Ontario, Canada
ISBN 978-0-88955-621-8
© 2014

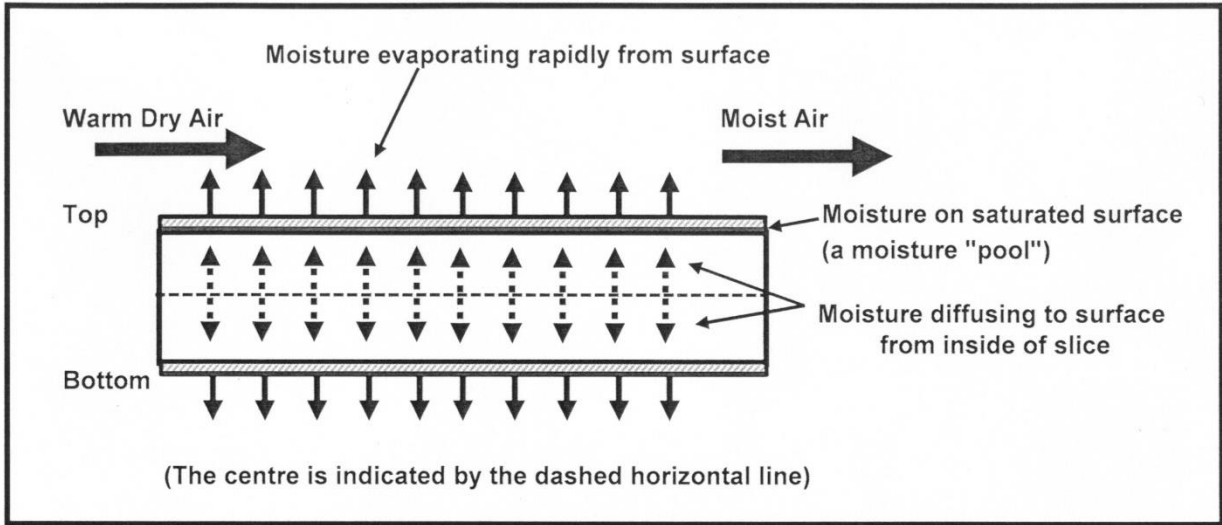

Figure 5-1: Moisture removal from the surface of apple slices during the early stages of drying

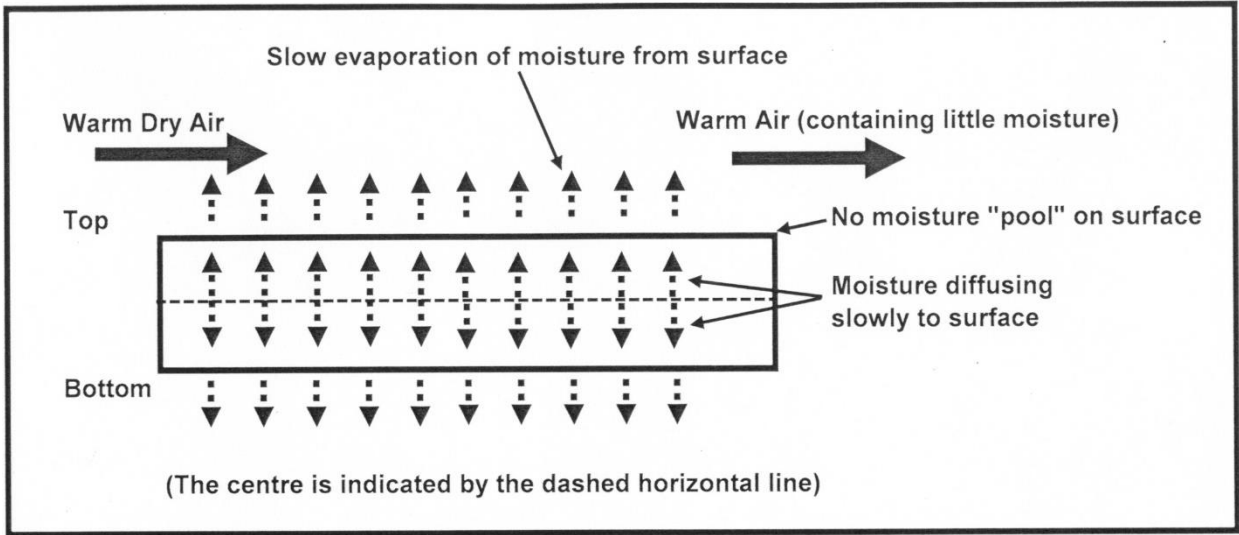

Figure 5-2: Moisture removal from the surface of apple slices during the later stages of drying

Note: The rate of drying is controlled by diffusion of moisture to the surface after the surface moisture pool has been evaporated.

If there is a thick skin or peel on one of the surfaces (such as in the case of hot yellow peppers), it will significantly reduce or completely eliminate drying on that surface.

There are very few things that we can do to try to speed up the drying process. We are limited by how fast the moisture can diffuse to the surface. This simply cannot be rushed. You should try to keep this description of the drying mechanism in mind whenever you are drying anything

As we shall see later, reducing the thickness of the slices is one method to decrease drying times. When the thickness is reduced, the distance moisture has to travel from the centre of the slice to the surface is also reduced.

Let's take a closer look at what happens during a typical drying process. In Figure 5-3, the moisture content of a material is plotted versus the drying time. This is just a general plot with no scale applied to the moisture content and the time axes. A similar plot could be prepared using the weight of the material versus time since the change in weight is due solely to the removal of water during drying.

When some materials are placed in a dryer, they may take a short period of time to warm up sufficiently before the water begins to evaporate. The warm-up period in Figure 5-3 is between Point A and Point B. In my personal experience, I have only observed a warm-up period when cold material was entering the dryer. In cases where the material was a room temperature, there may be no warm-up time observed.

Once the material is warmed up, evaporation of the water on its surface begins. As stated above, the surface may be covered with a film of water that resembles a pool. Evaporation from this pool takes place at a uniform rate and water from the inside of the material moves to the surface by diffusion to replenish the pool as moisture is removed. The constant rate drying period is between Points B and C in Figure 5-3.

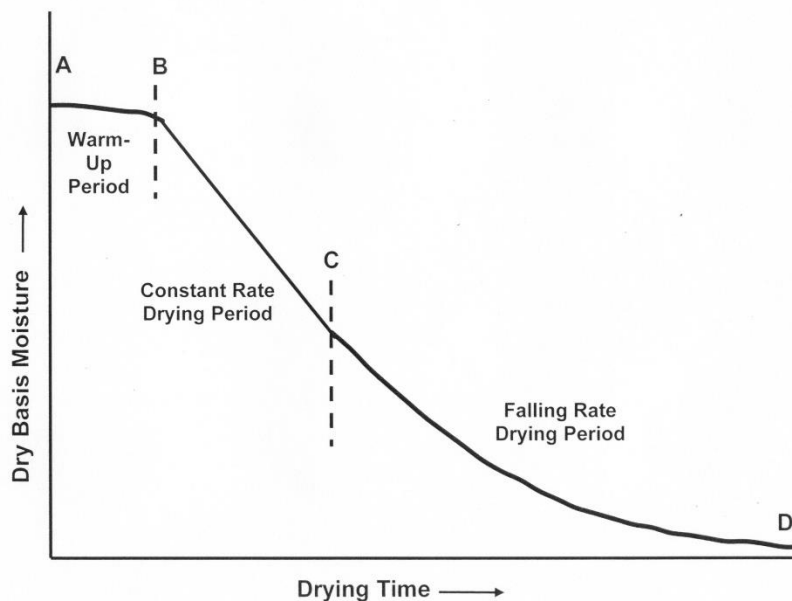

Figure 5-3: Typical stages of drying

Note how straight the line on the graph is during the constant rate drying period which indicates that water is being removed at a constant rate, as the name implies.

When the pool of moisture on the surface is depleted and water can no longer diffuse to the surface to maintain the constant rate of removal, we enter the falling rate drying period. From Points C to D in Figure 5-3, the rate at which water is evaporating becomes slower. As more and more water is evaporated, there is less water in the material which slows the rate of diffusion and reduces the rate of moisture loss. In addition, the texture of the material may change and slow diffusion as well. During the falling rate period, the material will tend to heat up since there is no longer enough evaporation taking place at its surface to keep the temperature down. In addition, evaporation may take place below the material's surface if there are cracks or pores from which the moisture can be removed.

To complete our discussion of the drying mechanism and stages of drying, we can look at the actual drying of a food product. In this case, the product dried very slowly which allows us to see the main stages of the drying process reasonably clearly.

Figure 5-4 shows how the weight changes during the time that drying is taking place. Labels have been included to show what is happening as the drying proceeds. No warm-up period was observed since the product was at room temperature and water began to evaporate almost immediately after the material was placed in the dryer.

For about the first six to eight hours, there was enough water on the surface of the material to support a constant rate of evaporation (i.e., the constant rate drying period). After about eight hours, diffusion of moisture from inside the material was not sufficient to replenish the moisture on the surface and the falling rate drying period began.

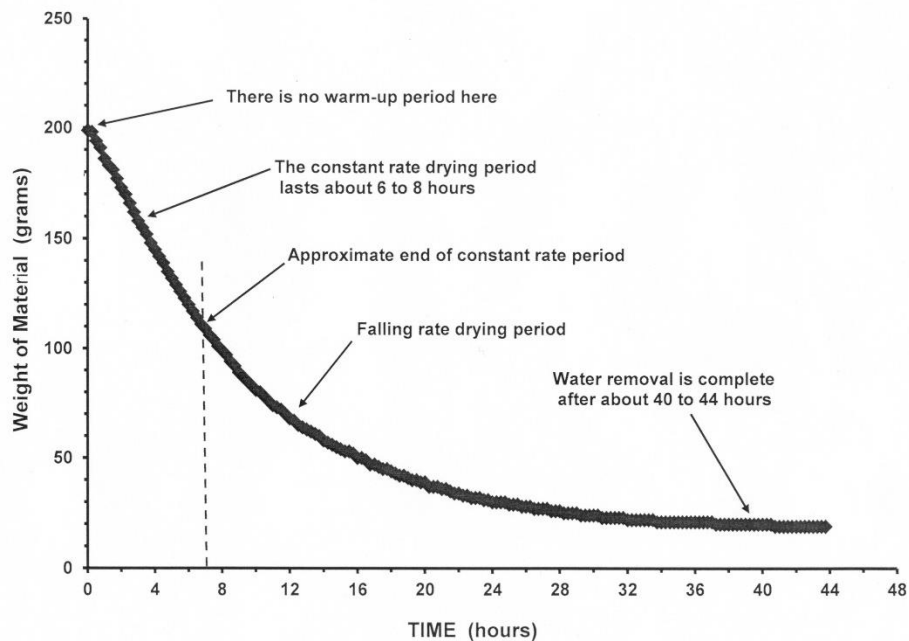

Figure 5-4: Drying stages for an actual food material based on weight

About 40 hours after the drying was started, water removal was complete. No more moisture was lost as can be seen by the horizontal line at the end of the drying run in Figure 5-4.

The weight of the material when the drying is completed is equivalent to the weight of the dry solids that are present, plus small amounts of water that are retained. The water may be tightly bound by the solids and not be easily removed.

Figure 5-5 shows the same drying test run with the moisture content plotted against drying time. The curve here, and in Figure 5-4 have the same characteristic shape and illustrate the same concepts in a slightly different manner. We will examine the calculations involved in a later section.

As stated above, most products do not take such a long time to dry. Apple slices, for example, reach their final target moisture in about eight to ten hours.

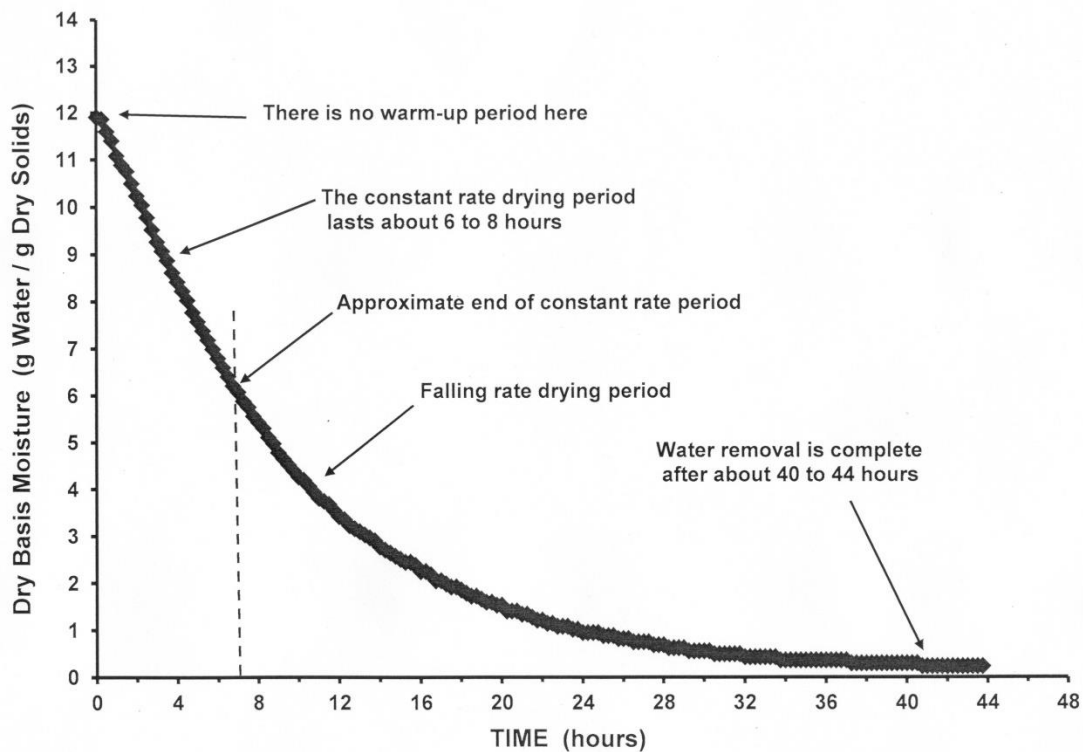

Figure 5-5: Drying stages for a food product using dry basis moisture content

5.3 Factors Affecting Drying

There are numerous factors which must be taken into account for successful drying. Some of these are related to the characteristics of the product itself, while others pertain to design aspects of the dryer. A brief description of each is provided below. Some of these factors “overlap”, so the discussion here may seem a bit repetitive at times.

5.3.1 Properties of the Product:

5.3.1.1 Shape of the Material:

There are three basic shapes which describe most materials which are being dried. They are (see Figure 5-6):

- Spheres
- Cylinders
- Flat Plates or Slabs

Each of these has different attributes which create a difference in drying properties.

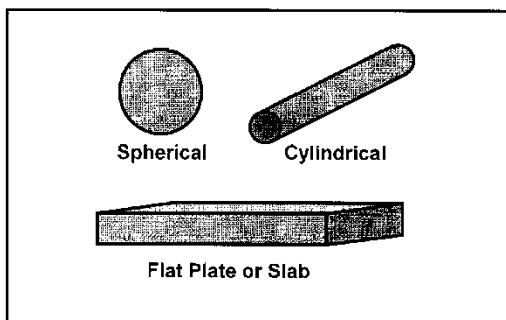

Figure 5-6: Spheres, cylinders, and flat plates or slabs

In the case of the sphere, there is a maximization of the amount of material contained within a minimum surface

area. The characteristic dimension of a sphere which controls its rate of drying is its radius, or half its diameter. This is because water must move from the centre of the sphere along its radius to reach the surface where it will be removed. Berries and peas are examples of spherically shaped products.

In Figure 5-7, it can be seen that if we double the radius of a sphere, the distance from the centre to its surface is correspondingly doubled.

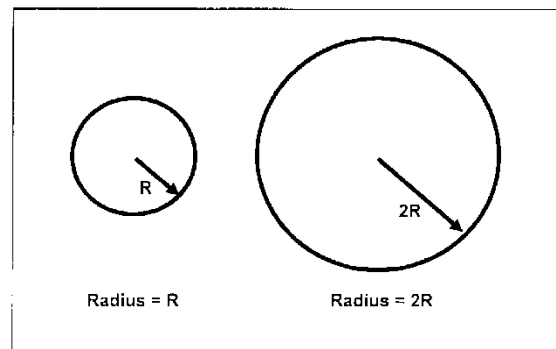

Figure 5-7: Doubling the radius doubles the distance to the surface of a sphere

The drying of cylindrically shaped products (e.g., whole carrots) is also controlled by their radius. Here too, moisture must travel from the centre along the radius to reach the surface. The main difference between drying spheres and cylinders is the ratio of their surface area to volume which is higher in the case of the cylinders.

Slabs or flat plates offer a large surface area to volume ratio which increases the rate of drying when compared to spheres or cylinders. The characteristic dimension that controls drying of flat slabs is one-half their thickness if both their top and bottom surfaces are exposed to the flow of air in the dryer.

We have already seen this in Figures 5-1 and 5-2.

Sometimes, the way in which we prepare a material for drying will determine the characteristic shape it has and the way it behaves during the drying process. Carrots are a good example for illustrating this point.

Whole carrots approximate the shape of a cylinder. Even though they may have some tapering from the wide end from which the leafy tops protrude to the rootlet end, they are still basically a cylinder. The majority of the moisture loss during drying will be from the outer curved surface of the carrot. The ends of the cylindrical-shaped carrot will have a much lower contribution to the loss of moisture since the ends account for a relatively small percentage of the total surface area. In cases where the material has many capillaries or “tubes” travelling along its length, as in the case of a stalk of celery, the end effects may be more pronounced.

If we cut the carrot crosswise into thin slices, the resulting pieces will behave more like flat plates or slabs during drying. Here, the flat top and bottom surfaces account for the majority of the surface area available for moisture loss. The narrow band of surface around the outside of each slice contributes very little to the overall drying.

Figure 5-8 shows an entire carrot with its characteristic cylindrical appearance, as well as some flat slices. The cylindrical and flat slabs configurations of the carrot are rather obvious. However, if the carrot is cut into thicker chunks, then the shape actually begins to approximate a sphere. These are the third shapes shown in Figure 5-8.

Looking at the thicker chunks of carrots, we can see that the outer curved surface accounts for an appreciable fraction of the total surface area available for moisture loss. While most of the moisture may still be lost through the two flat end surfaces, the outer curved surfaces may not be able to be ignored. When cut this way, it may be more appropriate to think of the carrot in terms of it being more of a sphere than a cylinder or flat plate.



Figure 5-8: A carrot as a cylinder, spheres, and flat slabs

5.3.1.2 Size or Thickness of the Material:

Water removal in a drying process depends on how far the water has to travel from the centre of the material to its surface. For this reason, large pieces of food tend to dry more slowly than smaller pieces of the same food. To facilitate drying, it is often best to use pieces which have a small diameter or are not excessively thick. While this factor is closely related to the shape of the material, it is worth mentioning on its own.

Figure 5-9 shows two samples of sliced apples. The slice on the left is just over

half the thickness of the slice on the right. As a result, it will dry more quickly than the slice on the left, even though they are from the same apple and have equivalent moisture contents.

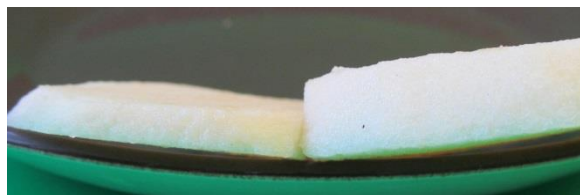

Figure 5-9: Thickness of apple slices

Actual examples showing the effects of thickness on the rate of drying are presented in a later chapter.

5.3.1.3 Composition, Structure, and Porosity:

These three factors have been grouped together since they tend to be inter-related. An open structure tends to be more porous than a tighter or more dense closed structure. Moisture is able to find its way through the pores and travel to the surface in products with a more open structure. The composition of the material itself has a significant impact on this.

Apple slices are a good example of a food product which dries quite rapidly. Less porous foods such as mango slices tend to dry somewhat more slowly.

5.3.1.4 Initial Moisture Content:

The actual amount of water present in a given material will influence how fast it may be dried to a desired final moisture level. It will take longer to dry tomatoes with a higher moisture content than it

will for similar tomatoes with a slightly lower moisture content.

5.3.1.5 Surface Characteristics:

One of the most frustrating things to dry is whole berries such as cranberries (see Figure 5-10). These berries have a waxy cuticle, or outer coating, that prevents moisture from escaping. Even after several days in a dryer at 50°C, tests in our lab showed that very little moisture had been removed from these berries. However, the berries from the same batch dried much more quickly when sliced in half and placed in the dryer under identical conditions.



Figure 5-10: Cranberries have a thick waxy cuticle that severely reduces moisture loss

This observation should not come as a surprise, if we consider that the function of the berry in nature is to protect the seeds and ensure reproduction of the plant. For this reason, the skin traps the moisture in the fleshy part of the berry which surrounds the seeds and prevents them from drying out. When we attempt to dry the berries, we need to recognize this and take appropriate steps such as cutting the berries open to permit the removal of the water.

Some fruits or vegetables may have deeply pitted surfaces which allow moisture to escape more easily and speed the drying process.

5.3.1.6 Amount of Surface Available for Moisture Loss:

This is closely related to the shape of the object as described above. One of the key ways in which the rate of water removal can be increased is to maximize the amount of surface area available for moisture loss. Cutting a product into thin slices increases the surface area while reducing its thickness. Both of these approaches are directionally correct in speeding up the rate of drying.

5.3.1.7 Seasonal Variation of Material:

Certain attributes of fruits and vegetables can vary from one growing season to the next. One of the most obvious is the size. In a good growing season, the fruit may be plump and juicy, while in a poor season, the fruit would tend to be smaller and less juicy. Such differences from one growing season to the next can have significant effects on the processing and drying of food crops.

In some cases, there may be differences from one field to another or between crops harvested several days apart. These factors must be acknowledged as part of the overall drying picture.

5.3.1.8 Differences in Varieties of Materials:

Different varieties of fruits and vegetables do not always have the same drying characteristics. Some tomato varieties, such as the Roma tomato, have been bred to have a lower moisture content than others. This is to increase their solids content for use in sauces and stews compared to others which may be used as garnishes or in salads where a higher moisture level is more acceptable. You can see the difference between two tomato varieties in Figure 5-11.



Figure 5-11: The Roma tomato on the right has striking differences from the tomato on the left

Different varieties of apples have different textures which affects their porosity and ultimately the rate at which water can be removed during drying.

While information about one specific variety may be helpful in establishing the approximate drying conditions of another, it should not be assumed that both varieties will dry in exactly the same manner.

5.3.2 Dryer Properties:

Just as characteristics of the material being dried can have an impact on the drying process, so too can various properties of the dryer. Here are some factors which should be considered.

5.3.2.1 Type of Dryer:

Each type of dryer has its own individual approach to water removal. Forced-air dryers rely on heated air being blown by fans across the product. In large industrial processes, the material may be on a mesh conveyor belt being moved through a series of large drying chambers, each with a different set of drying conditions.

By comparison, solar dryers often tend to be more gentle in the manner in which heated air is brought into contact with the product.

The wide variety of commercially available dryers demonstrates the impact that the type of dryer can have on the product and how one design may be more appropriate for a given application than another.

5.3.2.2 Dryer Design Features:

Manufacturers frequently incorporate features into their dryers to enhance such things as the uniformity of air distribution or the recovery of heat from exhaust air leaving the dryer. Such features may (or may not) have an impact on the actual drying of the product itself. Uniform distribution of air is extremely important to the water removal from the product. However, heat recovery from the discharged exhaust air would tend to be prompted

by financial considerations with respect to energy costs and would most likely have little effect on the actual drying process.

5.3.2.3 Air Temperature:

The temperature of the air used in the drying process is one of the major factors influencing the rate of drying (see Figure 5-12). Since water removal involves a change of state from the liquid to vapour form, increasing the energy input to a dryer by raising the temperature of the air will increase the rate of drying.

While this tends to be the general case, care should be taken to avoid excessively high temperatures which can damage the product, or create an undesirable situation of “case hardening”, which will be discussed later.



Figure 5-12: Temperatures of 50°C to 55°C are often best for food drying

5.3.2.4 Time Spent in Dryer:

The length of time during which the product is exposed to heated air within a dryer has a major impact on the overall drying process (Figure 5-13). Drying time is frequently coupled with air temperature and air velocity (see below) to define a drying process. Although we are mentioning it only briefly here, the importance of time to the overall drying process will become quite evident as we move through the following sections and chapters.



Figure 5-13: Time is an important factor in drying processes.

5.3.2.5 Relative Humidity of the Air Going into the Dryer:

Relative humidity is an indication of the amount of water vapour contained in a given amount of air divided by the maximum amount of water vapour the air could hold at that temperature. It is expressed as a percentage value. The moisture content of air entering a dryer will have an effect on the water removal capabilities of the air once it is heated.

Figure 5-14 shows a battery operated hygrometer indicating a relative humidity of 54% in the inlet air to a dryer at 22°C.



Figure 5-14: Air temperature and relative humidity

If the relative humidity of the initial air is high before it is heated, then the water content of the air (measured in grams of water per kg of dry air) will be high. This means that when heated, the ability of the air to remove water will not be as great as if the air had a lower initial water content.

5.3.2.6 Volumetric Air Flowrate:

Volumetric air flowrate is an indication of the volume of air being blown into a dryer in a given period of time. For large dryers, it may be measured in units of cubic metres per minute or per second. Since the volume of most dryers is a constant and the cross-sectional area of the dryer does not change, the volumetric flowrate has a direct impact on the linear velocity of the air in the dryer (see next item).

Volumetric air flowrates can be set by adjusting the speed of the fan or by other methods such as opening or closing louvres or adjusting volume control disks on certain types of fan assemblies.

5.3.2.7 Linear Air Velocity:

Linear air velocity really tells us how fast the air is moving in a particular direction through the dryer. As such, it has units of distance divided by time (e.g., metres per second). It is important for the linear velocity of the drying air to be high enough so that it can sweep the moist air away from the surface of the material being dried and replace it with a fresh supply of warm dry air.

Linear velocities of air can be measured using hand-held anemometers as shown in Figure 5-15.



Figure 5-15: A hand-held anemometer for measuring air velocities

5.3.2.8 Air Flow Patterns and Uniformity of Air Flow:

Based on personal experience with a wide variety of dryers, including large industrial units, the biggest single problem encountered in operating a dryer is establishing and maintaining a uniform distribution of airflow throughout the entire dryer. If the airflow is greater in one particular area than another, there will be uneven drying. The area with the increased airflow will tend to become dryer than the areas with the lower airflow. This means that the final product from the dryer will not have a uniform moisture content. There may be areas which are still damp and areas where the product can become overly dry.

Non-uniform airflow problems are particularly noticeable in dryers where the air is blowing upwards through a bed of product supported on a wire mesh.

In extreme cases where the airflow is sufficiently high, it may actually lift sections of material upwards, leaving open holes in the dryer bed. Because airflow is always seeking a path of least resistance, air will tend to rush through the "blow-hole" and over-dry the product around it while not drying the remaining product sufficiently.

5.3.2.9 Seasonal and Daily Variations in Weather and Air Conditions:

You may have noticed variations in the surrounding air between daytime and night time. In some cases, the daytime air may be very hot and feel quite dry. However, when the sun goes down, the air may feel quite cool and even moist or humid. These changes can have a pronounced effect on the operation of a dryer (see “Relative Humidity of Air Going into the Dryer”), as well as on the product leaving the dryer.

When product is removed from a dryer, it is often still warm and has a low moisture content. If it encounters cool, moist air, the product will begin to absorb moisture from the air and its moisture content will increase. This type of variation can also occur between the wet season and dry season in various countries. You need to be aware of any impact that moist air is having on the dried product as well as on the operation of the dryer itself.

5.4 Effects of Drying on the Finished Product:

Sometimes, food processors simply look at drying as a means of removing water from a product. They equate a successful operation as one in which they remove as much water from as much incoming material as possible in a given period of time. To speed the drying process, they heat the air to as high a temperature as they possibly can and use the highest volumetric air flowrate their dryer fans can deliver. While this may give them a high throughput rate (i.e., kg of product per hour), there needs to be some attention paid to the effects on the quality of the product.

When processors do this type of thing, they are actually showing their lack of understanding of the overall drying mechanism associated with food products.

Here is a brief overview of some of the effects improper drying can have on the finished product.

5.4.1 Nutritional Degradation:

One of the primary functions of food is to provide nutrients to the body. Among the components found in food are those which are sensitive to heat. These include vitamins. When subjected to excessively high temperatures the beneficial properties of these components are either completely destroyed or substantially reduced. For this reason, it is best to impose limits on the drying temperatures of most food products. This may be 50°C to 55°C for fruits and vegetables or just over 40°C for drying more sensitive herbs etc.

5.4.2 Loss of Structural Integrity:

If too much moisture is removed or the temperature of drying is too high, products may become brittle and literally crumble into small pieces rather than retaining their original desired structure. It may be necessary to have a brief period of high temperature drying at the very start to set the structure of a product, but this should be done very carefully.

Some processors may also use a higher temperature during the constant rate drying period when sufficient moisture is present to prevent the rise in temperature during these early stages of drying. Once the falling rate period of drying is expected to begin, they will lower the temperature of the drying air. Such procedures can complicate the drying process and may lead to problems if the temperature is not lowered. Savings in the overall drying time may not be all that significant.

My personal preference is to use the same temperature throughout the entire drying process. In this way, there is no risk of forgetting to reduce the air temperature, or keeping the temperature elevated as you enter into the falling rate drying period. You can be assured that the air temperature is suitable at all times.

5.4.3 Reduction in Functionality:

Just as vitamins lose their beneficial properties when exposed to excessive temperatures, other functional components present in food products may also experience undesirable changes due to improper drying. In cases where there are starches present, using temperatures over approximately

60°C can gelatinize the starch. Products may require the starch to be ungelatinized so that it will thicken later when used in the finished product. If the starch is gelatinized in the dryer, this will not happen.

5.4.4 Flavour and Aroma Changes:

Flavour and aroma are often due to the presence of essential oils. It is these oils which make oranges smell and taste so pleasant. If attention is not paid to the drying conditions of products containing delicate oils, the oils themselves may be driven off by the heat or oxidized by chemical reactions with oxygen in the heated air. Some processors collect the volatile aromatic compounds leaving their processes by condensing the vapours.

5.4.5 Colour Changes:

We are all familiar with the colour that develops when we toast bread (Figure 5-16). While this may be okay with bread, it may not be acceptable if your final product must be white in colour. Browning or toasting can occur by several reaction pathways during the drying process if conditions of temperature and time are excessive.

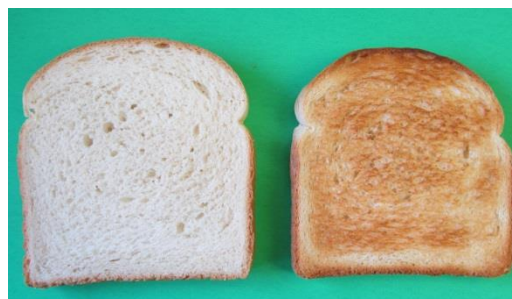

Figure 5-15: Toasting can create significant colour changes in a product

5.4.6 Loss of Nutrients by Water Leaching:

This point is a bit more subtle than the previous ones. As drying proceeds, water moves from the inner portions of the food material to the outer surface where it is removed by evaporation. There are often nutrients dissolved in the water that are drawn to the surface as the water diffuses outwards. When the water evaporates upon contact with the drying air, a thin layer of these nutrients may be left as a deposit on the surface.

In cases where the dried material is re-hydrated by placing it in hot or boiling water, the nutrient deposits on the surface can be easily washed away and be lost in the bulk of the water that will ultimately be discarded.

5.4.7 Case Hardening:

Care must be taken in the way information is interpreted when dealing with food drying.

Some dryer operators may look at the effects of temperature on the rate of drying and conclude that if 55°C (or 60°C) is a good temperature at which to dry food quickly, then 80°C will be faster and better. An immediate thought is that they can dry more product in a day by simply using a higher temperature in the dryer. When they try to dry foods, especially mangoes, at 80°C, they run into problems removing the moisture from the mango slices. They may find that the drying actually takes longer, and are then left wondering what could have possibly gone wrong.

This is where we also need to recall how the drying process occurs. You may recall from Figures 5-1 and 5-2 that moisture is removed from the surface of the material first. Moisture that is still inside then needs to diffuse to the surface where it will eventually be removed by the warm air passing through the dryer.

As moisture is removed from fruits or vegetables, their cellular structure begins to collapse and the cells become smaller. The result of this is the shrinking of the product as it dries.

At 80°C, moisture is removed quite rapidly from the surface of the material. It may be removed so fast that the hot air starts to make a hard dry layer on the outside of the mango slices due to the collapsing of cells at the surface. This layer is much like a skin that can trap moisture inside the slices. It severely reduces the efficiency of the drying process and may prevent the trapped moisture from escaping. We call the development of the skin-like shell of hard material on the outside of the product “case hardening”.

Once an outer shell has formed, there is little that can be done to dry the product in a controlled manner. An additional problem is that many dryer operators look at the case-hardened mango slices and think that they are dry. The slices actually appear dry enough to remove from the dryer when the operator feels them and bends them. Being consider “dry”, the slices may be prematurely removed from the dryer and be packaged for sale.

After packaging, moisture at the centre of the slices may begin to travel very slowly through the thick layer of collapsed cells at the surface of the

slice. It then goes into the air inside the package where it condenses on the cooler packaging surfaces or product to form water droplets. These water droplets are now available to support mold growth on the product slices. Of course, any mold growth will make the product un-saleable and unfit for eating.

Figures 5-16 and 5-17 illustrate how case hardening occurs.

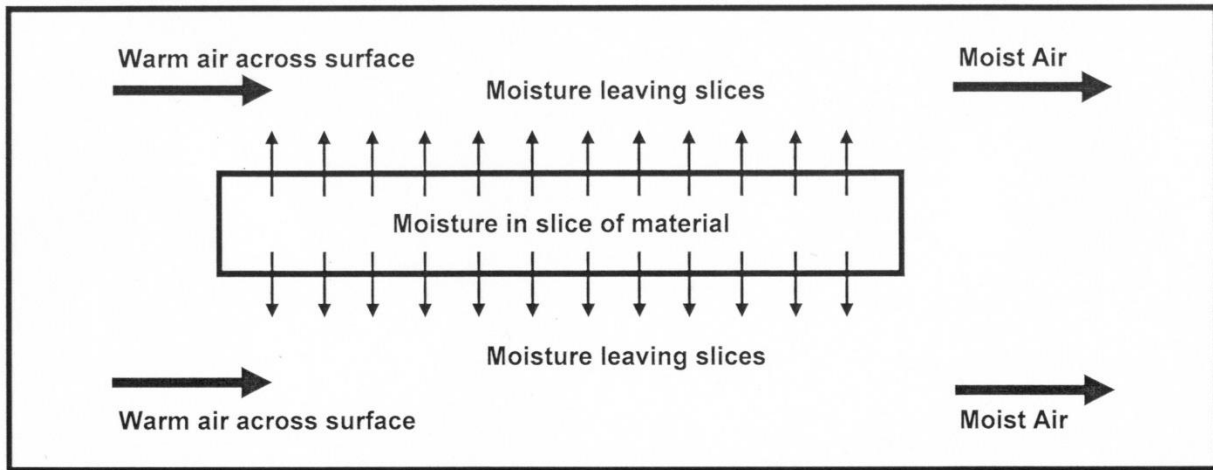

Figure 5-16: Drying of sliced material with warm air

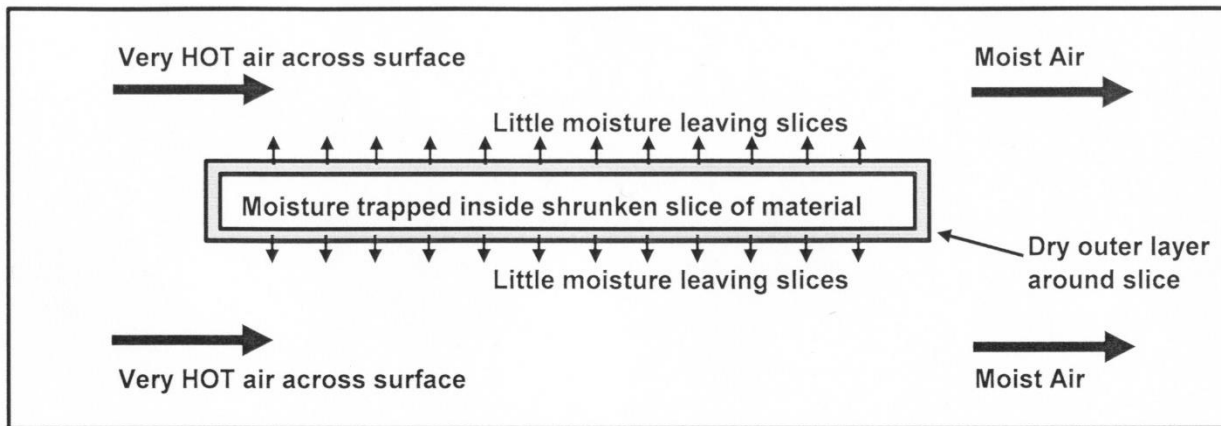

Figure 5-17: Excessively hot air being used to dry sliced material.

Note the dry outer layer around the slice and its shrunken size

6. Some Key Aspects of the Drying Process

6.1 Introduction

Part of being able to understanding the overall drying process for any application is being aware of the key aspects that affect it.

This understanding should begin at the “grass-roots” which is the basic design of the dryer and build from there to include such things as the delivery of drying air into the drying chamber and what particular actions you can take to improve or otherwise alter the performance of the dryer.

In this chapter, we will look at the roles of air temperature and velocity, as well as product thickness and surface characteristics on the drying of fruits and vegetables.

6.2 Basic Design of a Forced-Air Dryer

While it is not our purpose to teach anyone how to build a food dryer, we should look at some of the fundamental design features of dryers to understand how they function.

Forced-air dryers are usually designed as a closed cabinet equipped with a fan inside to blow air through the unit. There are many interesting designs and arrangements to suit various special drying needs. Figure 6-1 shows a diagram of how a typical forced air dryer may look.

Air is brought into the dryer by the fan which then blows the air across heating coils or through gas flames to warm it. Once the air is heated, it has the ability to hold more moisture than cooler air. The increased water-holding capacity of the heated air is a key factor in drying.

The heated air then travels to the drying chamber of the unit where the material to be dried is located. In most cases, moist food products are spread on wire mesh racks within the drying chamber.

When the heated air passes over the moist surfaces, it picks up water through the process of evaporation. The air then carries the water away from the food and eventually out of the dryer. As the air picks up moisture, it cools and its moisture content increases. This reduces its ability to pick up additional moisture as it continues its path through the rest of the dryer.

Chapter 6:
An Introduction to the Dehydration and Drying of Fruits and Vegetables

Donald G. Mercer, Ph.D., P.Eng., FIAFoST
Department of Food Science
University of Guelph
Ontario, Canada
ISBN 978-0-88955-621-8
© 2014

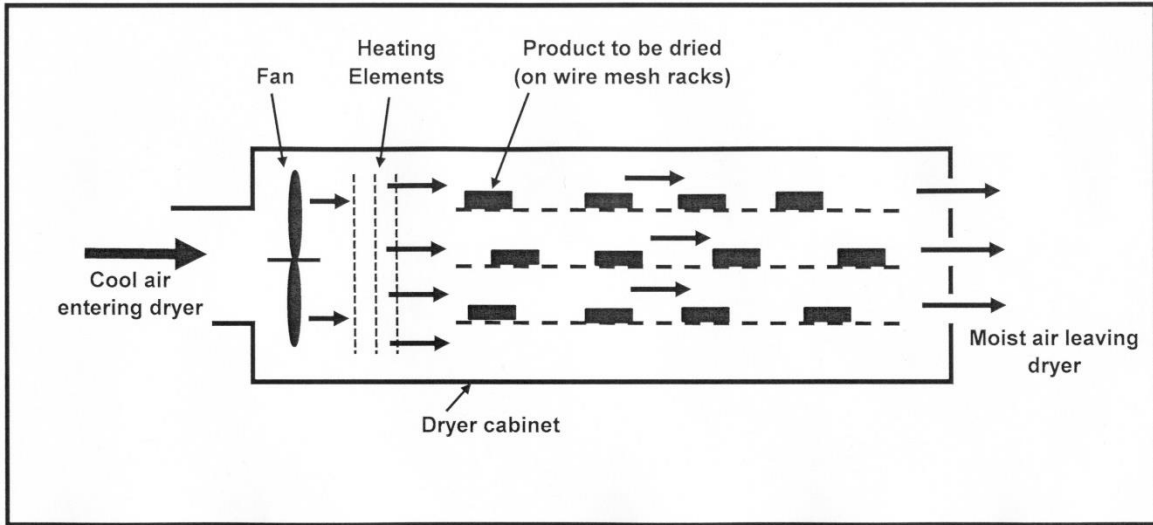

Figure 6-1: Diagram of a typical forced-air dryer

Freshly heated air is continuously blown into the dryer, while moisture-rich air is constantly forced out of the dryer by the incoming air. With sufficient time, the moisture content of the food in the dryer will have reached its desired target level.

It must be realized that just because the outside surface of the fruit looks and feels dry, there is still a moisture gradient in the individual pieces of fruit. That is, the outer portion is actually drier than the inner portion. In addition, because the air is flowing over its surface, the fruit near the point where the air enters will be drier than the fruit near the point where the air leaves the dryer. This is because the temperature of the air decreases as it picks up moisture. As the air passes through the dryer, it picks up more and more moisture, as well as cooling, and may become saturated to the point where it can pick up no more moisture. Many processors move the racks of fruit from the exit end of the dryer to the inlet end of the dryer part-way through the drying

process to help reduce this uneven drying tendency.

It is possible to control the temperature of the air in a forced-air dryer by adjusting the heater's temperature controls. The speed (or velocity) at which the air moves through the dryer can be controlled by adjusting the speed at which the fan is operating. The velocity of the air must be sufficiently high to evaporate the moisture from the surface of the food in the dryer and sweep this moisture-rich air out of the dryer. Air flows that are too low will not have the desired effect and the efficiency of the dryer will be disappointing.

It is usually best to have the air flowing across the surface of the material rather than coming in from the bottom of the dryer and travelling upwards through the material being dried. This ensures better air distribution and better exposure of the food to the drying air. However, some products may need to be dried using upwards or downwards air flows.

Dried product should be allowed to cool after it has been removed from the dryer. It should never be packaged or put into a storage container while still warm. Even though it appears to be totally dry, there will still be a trace of moisture left inside. Warm products may “sweat” in the package. By this, we mean that small amounts of moisture may still leave the dried products and collect on the inside of the cool packaging material as tiny droplets of water. These water droplets can then support mold growth.

6.3 The Role of Air Temperature:

As mentioned several times, the temperature of the drying air is one of the most important factors for the drying of a food product. Peppers can be used as an example to illustrate this point.

In order to show the effects of temperature on the drying of peppers, a forced-air dryer was used in the laboratory (see Figure 6-1). Hot yellow peppers were washed, peeled, and cut into quarters lengthwise for these tests. After the seeds were removed, the sliced peppers were placed on a rack which was connected to a balance on top of the dryer (see Figure 6-2). In this way, the weight of the peppers could be recorded during the entire drying process without opening the dryer.



Figure 6-1: Laboratory tray dryer



Figure 6-2: Rack inside tray dryer linked to balance on top of dryer

Two different temperatures were used: 50°C and 60°C. The speed of the air was kept constant at 0.50 metres per second, since we know that it can have an effect on drying and we did not want to introduce any additional factors into this set of experiments. Figure 6-3 shows a graph of the weight of the pepper slices during the time the drying tests were run. There is a curve for each temperature.

From Figure 6-3, it can be seen that the weight of the peppers decreases faster with the air temperature at 60°C than it does for 50°C. No actual values have been placed on the graph since it is the general trend that we would like to emphasize here.

For most food products, it is best to use drying temperatures of 50°C to 55°C. The temperature should generally not exceed 60°C. The main reason for this is because higher temperatures can destroy nutrients within the food itself. Without these nutrients, the food loses much of its dietary importance.

Regrettably, many people think that the hotter the air, the better it will be for drying the food material. This is an incorrect assumption that can lead to some serious problems, in addition to destroying some of the nutrients contained within the food. We have already discussed “Case Hardening” in the previous chapter.

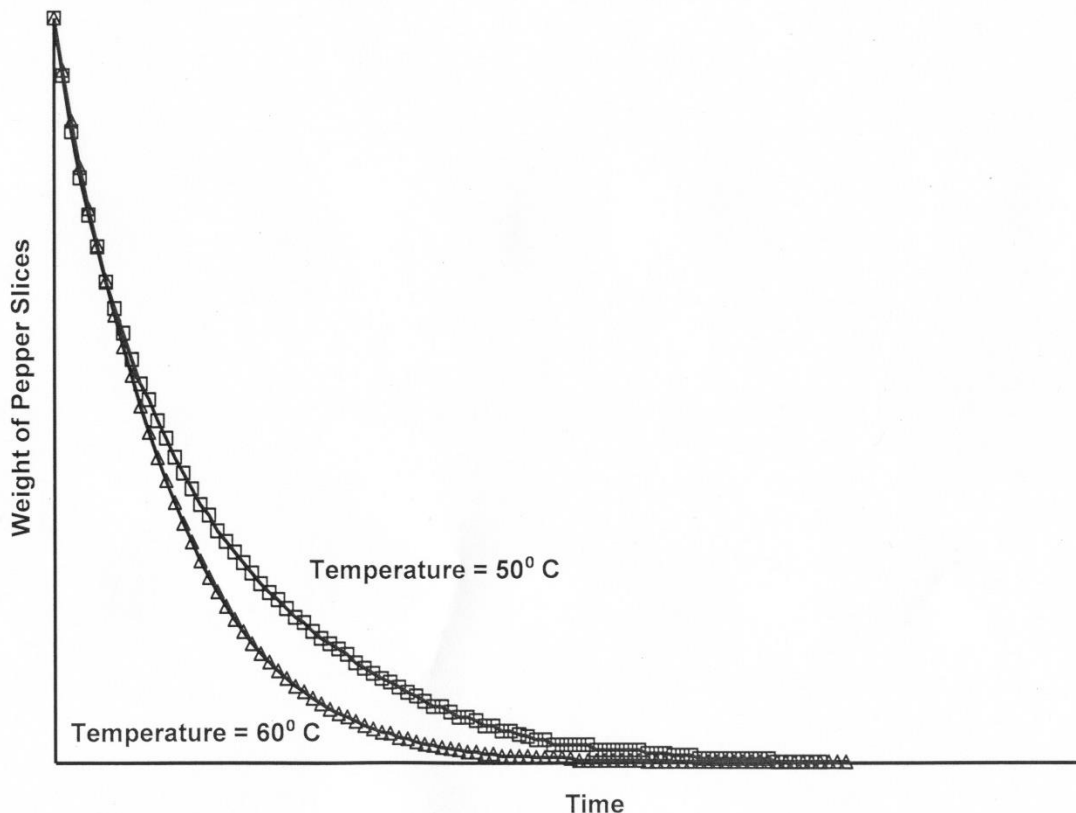

Figure 6-3: The effect of temperature on the drying of hot yellow peppers

Before leaving our discussion of the effects of temperature on the rate of drying, let's take a slightly different look at it. If we have identical weights of peppers with identical initial moistures, we can re-draw Figure 6-3 with the moisture content on the vertical axis as shown in Figure 6-4.

In Figure 6-4, a horizontal dashed line has been drawn to indicate a constant moisture content. At points where this line crosses the drying curves for each temperature, a dashed line has been

dropped vertically. The two vertical dashed lines meet the horizontal axis for "time" at the points labelled t_1 and t_2 .

t_1 is the time for the sample dried at 60°C to reach a certain moisture content. It is shorter than t_2 which is the drying time at 50°C . This clearly shows the impact of temperature on the drying of the pepper slices and how you can alter the rate of drying by changing the temperature of the drying air. However, you must remember what we said earlier about going above about 55°C .

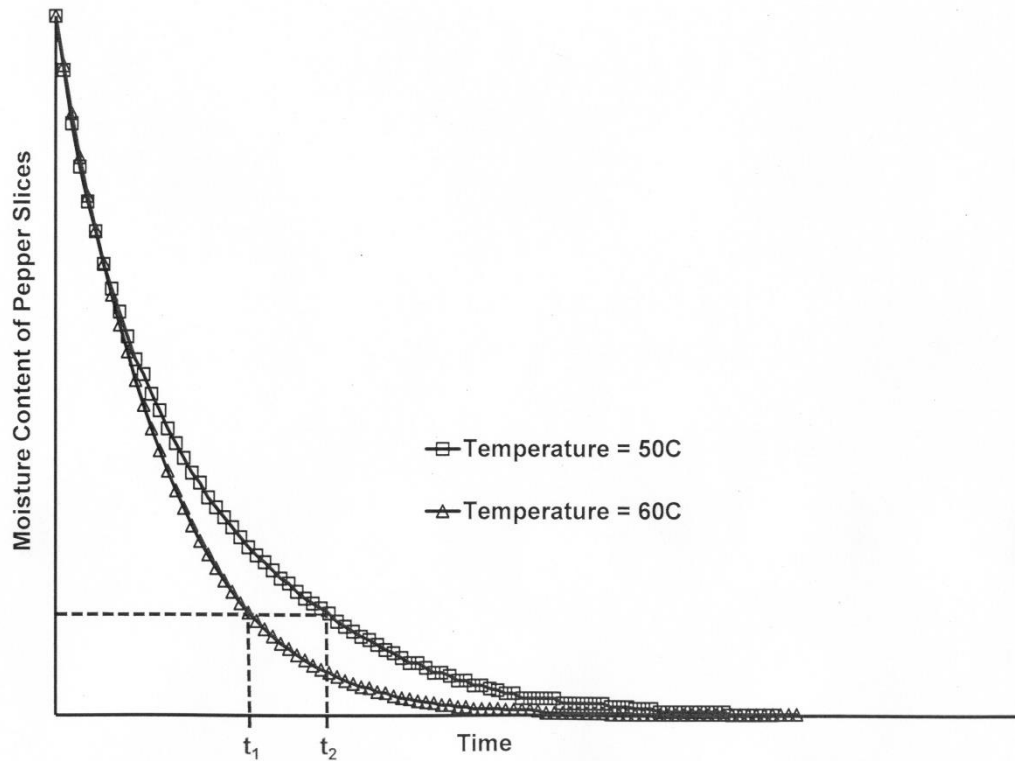

Figure 6-4: Times required to reach equal moisture contents at two drying temperatures

6.4 The Role of Air Velocity:

In addition to the temperature of the air used for drying, the velocity, or speed, at which the air is travelling is also an important factor in drying. We will continue to use pepper slices as an example for our discussions

When there is no movement of air across the surface of the pepper slices, air at the surface becomes saturated with water. As a result, water on the surface cannot be removed. If this saturated air is replaced by fresh unsaturated air, the unsaturated air can pick up more of the moisture from the pepper surfaces. If the air is kept moving, the drying process will continue at a satisfactory pace. In drying terminology, a layer of air clinging to the surface of a material and preventing efficient moisture removal is called a "stagnant boundary layer". It is not moving, so it is stagnant. Since it is between the surface of the material and the outside air, it is considered to be a boundary layer.

In drying studies, we are often concerned with how fast the air must be moving to sweep away the stagnant boundary layer. Tests can be done

using different air speeds to determine the effects of air speed on the rate of drying.

Figure 6-5 gives us a look at the effects of air velocity on the drying of pepper slices in a laboratory dryer. The air temperature used for drying the pepper slices in Figure 6-5 has been kept constant at 50°C.

An air speed of 0.25 metres per second allows the peppers to dry reasonably well. However, when the speed is increased to 0.50 m/s, there is a noticeable improvement in how fast the drying occurs. This is because the faster air flow is better at sweeping away the stagnant boundary layer of air around the moist pepper slices. The air at the surface that has picked up moisture is being continuously replaced by fresh unsaturated air which is very efficient at removing moisture.

Air velocities higher than 0.5 m/s were found to have very little additional impact on improving the rate of drying for work in our laboratory dryer. For all drying trials, 0.5 m/s was considered as being the optimal air velocity.

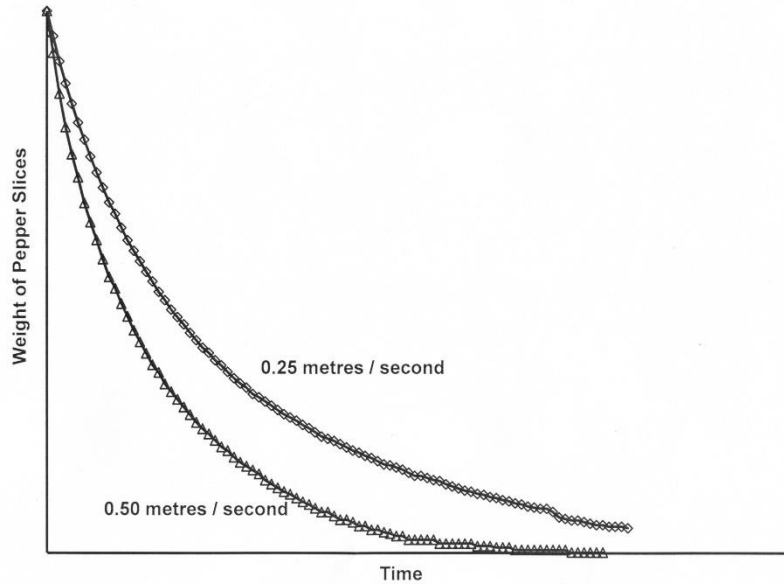

Figure 6-5: The effects of air velocity on the drying of peppers at 50°C

6.5 The Effect of Thickness on Drying:

In Figures 5-1 and 5-2, we showed how moisture travels from the centre of apple slices to the surface where it is removed by the air passing through the dryer.

The important thing to recognize here is that as the slice of material gets thicker, the distance from the centre of the slice to the surface increases. When the distance increases, the time it takes for the water to travel from the centre to the surface also increases. This means that it will take longer for the product to dry.

Figure 6-6 shows the effects that the thickness has on the drying of apple slices at 50°C and an air velocity of 0.5 metres per second. This graph has been included since similar tests have not been done in our lab for peppers. However, the same trends as shown for apples have been observed for other fruits and vegetables studied in this manner.

Just as a matter of clarification, the change in the weight of the apples is due entirely to the removal of water. The steeper the slope of the curves in Figure 6-6, the more rapid is the removal of water.

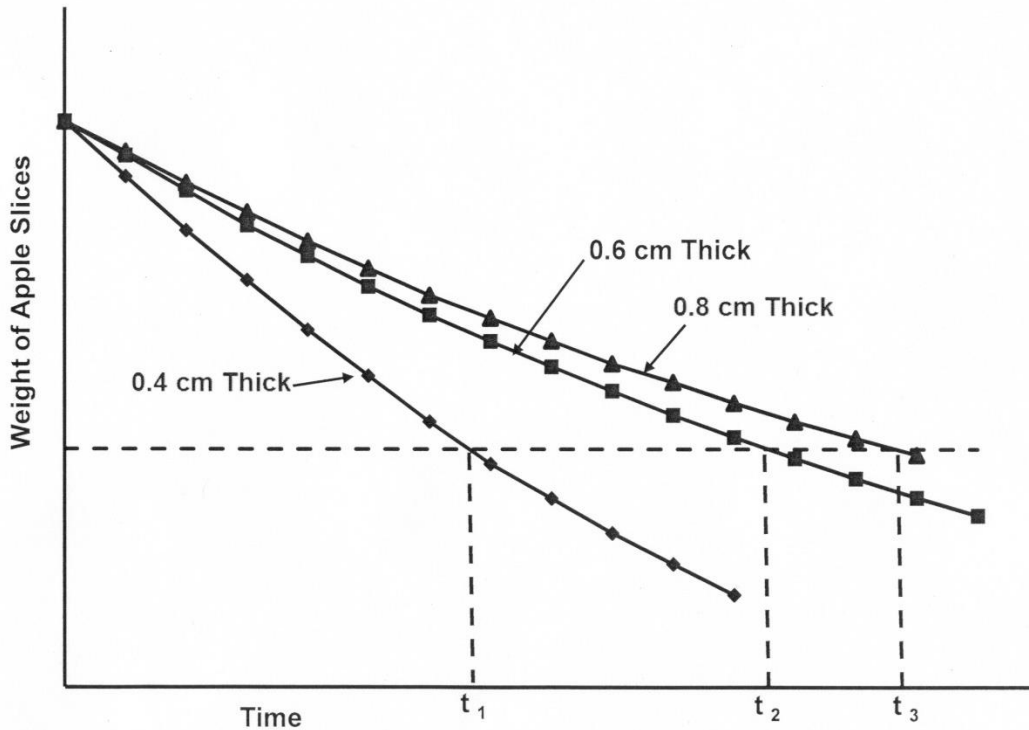

Figure 6-6: Effects of thickness on the drying of apple slices

As can be seen, the 0.8 cm thick slices dry more slowly than the thinner slices. This is because water at the centre of the slice has further to diffuse and reach the surface in the thicker slices than it does in the thinner slices.

t_1 is the time required for 0.4 cm thick slices of apples to reach a certain moisture content. It is noticeably shorter than the times taken to dry 0.6 cm thick slices (t_2), and 0.8 cm thick slices (t_3), to the same moisture content.

In most fruit and vegetable drying work, a thickness of 0.5 to 0.6 cm (approximately $\frac{1}{4}$ inch) is used. It is a convenient thickness to visualize when slicing the product, and it makes the slices easy to handle without tearing or ripping them. They are also thin enough to dry reasonably quickly and the final dried product is not excessively thick.

6.6 The Effect of Surface Characteristics on Drying:

The characteristics of the surface of a material have a significant impact on the manner in which it dries.

In the case of peppers, it is not really possible to cut slices into different thicknesses. The fleshy portion of most peppers, including hot yellow peppers, is generally quite uniform and does not usually exceed a reasonable thickness for drying.

Peppers have a waxy outer surface that is designed to keep moisture contained as a nutrient for the seeds which are inside (see Figure 6-7).



Figure 6-7: Note the waxy layer on the outer surface of this hot yellow pepper

Many fruits, especially berries, have a thick waxy outer surface (or “cuticle”, as it is called) to prevent the loss of moisture. Keep in mind that in drying, we are trying to get the moisture out, while nature is trying to keep the moisture in. It is critical to recognize that you should not fight nature, but that you must take alternate steps to overcome the problem.

Figure 6-8 is a graph comparing the water removal from whole hot yellow peppers with that of similar peppers cut in half to expose their inner fleshy surface.

Occasionally, things happen during drying that cannot be readily explained based on preliminary observations. This happened in a set of drying trials using apple slices. A mechanical meat slicer was being used to prepare the apple slices with as uniform and exact thicknesses as possible. Slices with thicknesses of 4 mm and 6 mm showed the expected trend with the thinner slices dryer faster than the thicker ones. However, when tests were conducted on 8 mm thick apple slices, they dried faster than the 6 mm thick slices, which was totally unexpected.

Closer inspection of the 8 mm thick apple slices showed that as they were passing through the slicer, each piece was being bent. This bending created tiny stress cracks in the thicker slices. No such cracking occurred in the thinner slices which were more flexible and could tolerate the bending without any problems. These tiny cracks increased the rate of water loss from the thicker apple slices and made them more difficult to handle due to potential breaking apart. Once this problem was identified an alternate arrangement was found using a mandolin slicer that did not bend the slices. Using a mandolin slicer is not recommended due to safety considerations. The exposed metal blade can be a hazard, even when using the recommended guards.

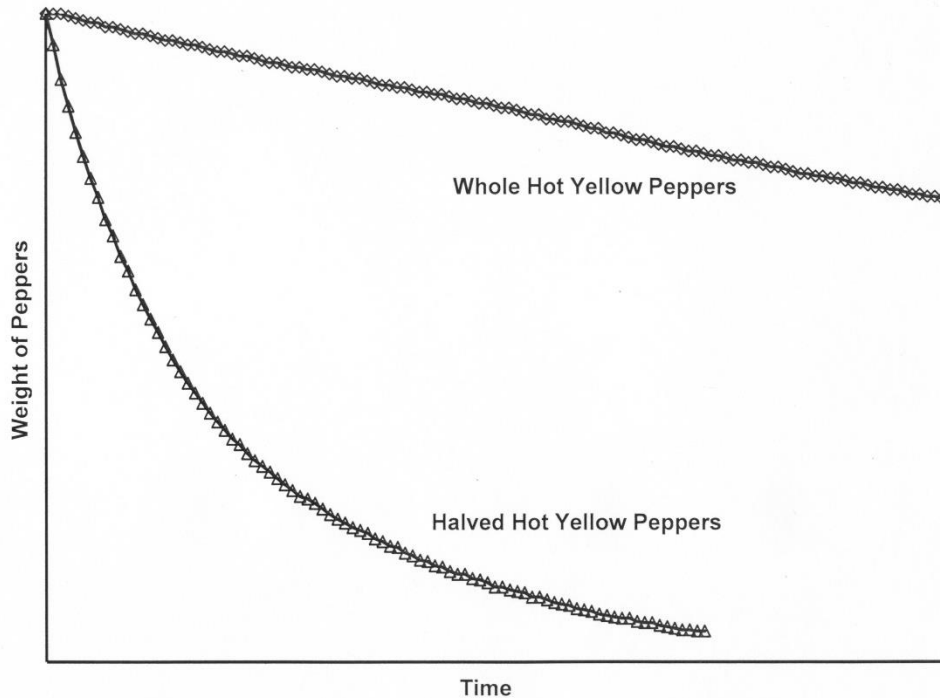

Figure 6-8: Comparison of water removal from whole and halved hot yellow peppers.

No values for the actual weights of the pepper samples and no times are specified in Figure 6-8. This has been done deliberately in order to focus on the overall trend, which is quite obvious. Due to its outer waxy covering, the whole hot yellow pepper loses its moisture very slowly compared to similar peppers which have been cut in half.

Based on laboratory drying data plotted in Figure 6-8, it would take about 18 days for the whole hot yellow peppers to be sufficiently dried. By this time, they would probably not be suitable for consumption since they would be showing signs of severe quality deterioration due to their prolonged exposure to the hot drying air. In addition, it is simply not economical to dry any material for longer than absolutely necessary. In comparison,

the halved peppers would be dry in about 33 hours.

Increasing the surface available for moisture loss is a good way to improve the rate of drying.

Because they have a waxy outer coating, peppers can only lose moisture through their exposed inner surfaces when they are cut or sliced.

Figure 6-8 showed us how simply cutting the hot yellow peppers in half made a tremendous difference in how fast moisture could be removed. The question now arises as to whether or not there would be any benefits to cutting the hot yellow peppers into narrower slices. In Figure 6-9, we can see what happens when hot yellow peppers are sliced into halves, quarters, and eighths lengthwise.

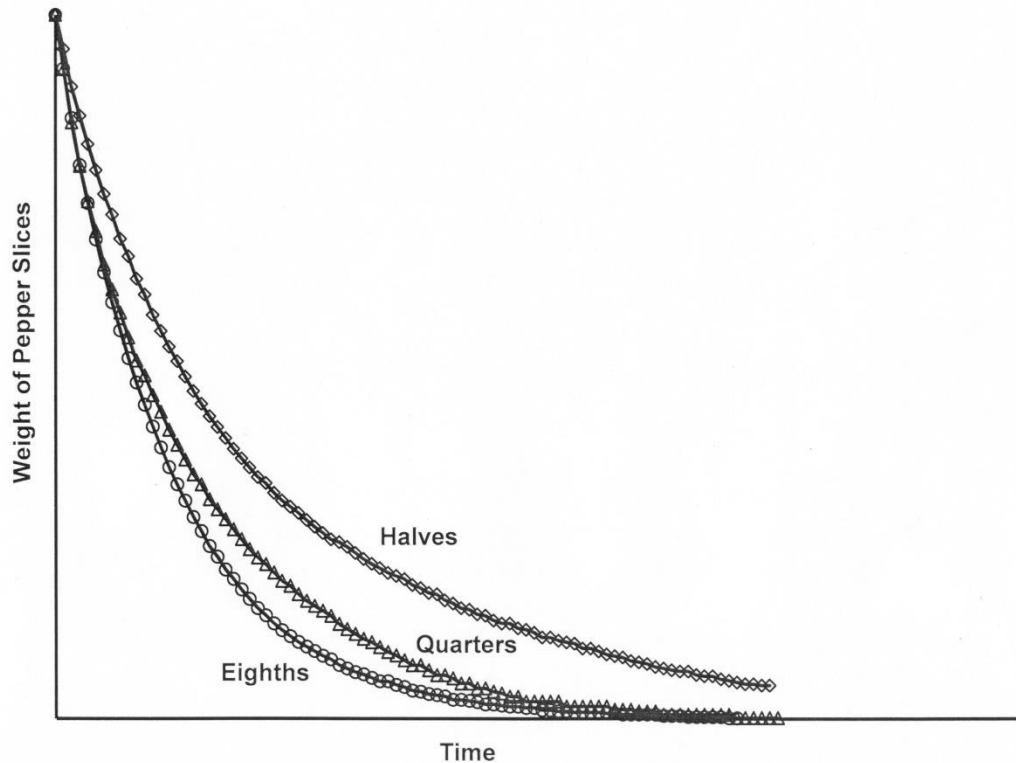

Figure 6-9: Effect of slicing on the drying of hot yellow peppers

As can be seen, there is a definite advantage in cutting the peppers into narrower slices. By doing so, more surface area is exposed to the drying air along each side of the narrower slices, which speeds the rate of water removal.

Let's consider the moisture content of the pepper slices rather than their actual weight. Figure 6-10 shows this. The curves themselves have the same general shapes as in Figure 6-9. If we were to include numerical values on these graphs, the exact differences could be quantified. However, we simply want to focus on relative comparisons at this time and not complicate things by including numerical

values which will be done in a later section.

We are starting with all samples having the same moisture content. The time required to reach a specified moisture content for the peppers cut into eighths lengthwise (i.e., t_1 in Figure 6-10) is less than that for the peppers cut into quarters lengthwise (i.e., t_2) and much less than the time for the peppers cut in half lengthwise (i.e., t_3). Actual times to reach a suitable level of dryness for the eighths and quarters would be about 16 hours and 20 hours, respectively – a noticeable improvement compared to the 33 hours for the halved peppers.

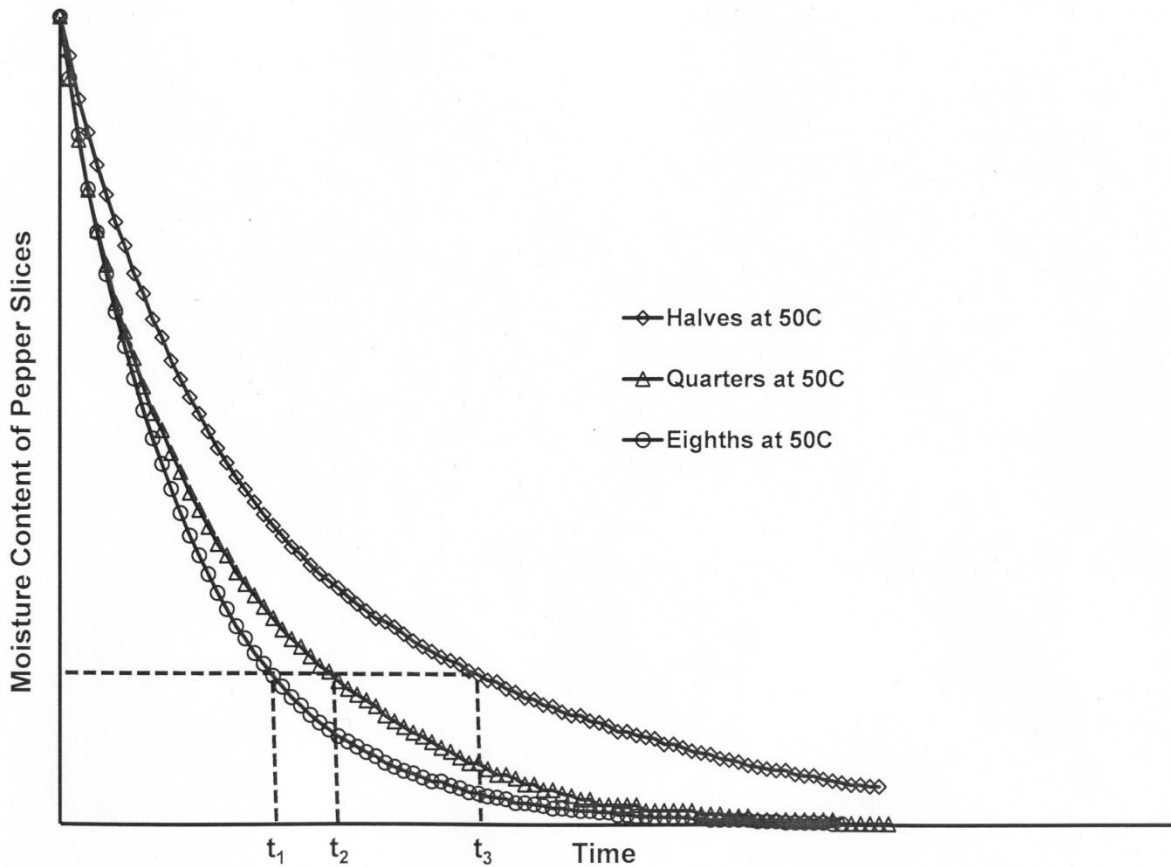

Figure 6-10: Times required to reach the same moisture content with different slicing of hot yellow peppers

Taking a closer look at Figure 6-10, the difference between t_2 and t_3 is greater than the difference between t_1 and t_2 . Much of this can be attributed to adding only two extra cut edges in going from one half-slice to two quarter-slices, while going from two quarter-slices to four eighth-slices adds four extra cut edges that could lose moisture. It was expected that the differences between the times should be equal. The actual drying experiment showed that when the hot yellow peppers were cut in half lengthwise, the slices had a tendency to curl in on themselves and reduced the amount of surface area available for moisture loss.

6.7 The Bottom Line:

Based on the trends presented in this section, it can be seen that the following factors play a key role in determining the rate at which materials dry:

- i. temperature of the drying air
- ii. velocity of the drying air
- iii. configuration (shape or thickness) of the material being dried

These factors must all be kept in mind for any drying activities.

7. BASIC DRYING-RELATED CALCULATIONS

7.1 Introduction:

In most drying activities, there will be some mathematical calculations required. This may be determining how much water is present in a particular product, or calculating how much water must be removed to reach a desired finished product moisture.

Regardless of the situation, it is always best to develop a disciplined step-wise approach to all your calculations. By understanding why each of the steps is being performed, your ability to successfully solve a problem should increase noticeably.

Throughout this chapter, we will use a structured method to demonstrate each of the sample calculations. In all cases, dimensions will be included in the detailed mathematical calculations. This **dimensional analysis** is an important way of minimizing errors and assisting in establishing the basic mathematical steps for solving a problem or doing a mathematical conversion.

Initially, you may not see the benefit of dimensional analysis, and you may even feel that it is a waste of time. However, when the calculations become more difficult, dimensional analysis can be an extremely useful tool.

You should try to avoid memorizing equations or formulae. It is far better to base your calculations on following the water and solids in your drying calculations. Most drying scenarios can be reduced to looking at the amount of water and solids you have at the beginning of the process. You can then work with the amount of water being removed and the solids present to calculate the final moisture of the dried material. While this may seem to be somewhat of an over-simplification, it is generally not far from the truth.

Where there are many detailed calculations in this section, we may not use the two-column format employed in the previous sections of the manual. In this way, we can present the calculations in a manner that is easier to visualize.

Chapter 7:
An Introduction to the Dehydration and Drying of Fruits and Vegetables

Donald G. Mercer, Ph.D., P.Eng., FIAFoST
Department of Food Science
University of Guelph
Ontario, Canada
ISBN 978-0-88955-621-8
© 2014

7.2 Ways of Expressing Moisture Content:

7.2.1 Wet Basis Moisture:

One way of expressing how much water is present in a material is to divide the amount of water present in a sample by the total weight of the sample and multiplying this value by 100%. The result is the percent moisture the sample contains. Since the total weight of the sample contains the weight of water and solids in the sample, the value is referred to as the percent moisture on a wet basis.

$$\% \text{ Wet Basis Moisture} = \frac{\text{Weight of Water in the Sample}}{\text{Total Weight of the Sample}} \times 100\% \quad (\text{Eq'n 7-1})$$

If you know the percent moisture present in a sample, you can easily calculate the percentage of solids present, based on the relationship:

$$\% \text{ wet basis moisture} + \% \text{ solids by weight} = 100\% \quad (\text{Eq'n 7-2})$$

$$\text{Therefore: } \% \text{ solids by weight} = 100\% - \% \text{ wet basis moisture}$$

Sample Calculation 7-1:

If we have 175.2 grams of hot yellow pepper slices containing 160.5 grams of water, what is the wet basis moisture content of the pepper?

$$\begin{aligned}\% \text{ Wet Basis Moisture} &= \frac{\text{Weight of Water in the Sample}}{\text{Total Weight of the Sample}} \times 100\% \\ &= \frac{160.5 \text{ g water}}{175.2 \text{ g total weight}} \times 100\% \\ &= 91.6\%\end{aligned}$$

Therefore, the wet basis moisture of the peppers is 91.6%.



From this, the percentage of solids by weight can be calculated.

$$\begin{aligned}\% \text{ solids by weight} &= 100\% - \% \text{ wet basis moisture} \\ &= 100\% - 91.6\% \\ &= 8.4\%\end{aligned}$$

From the wet basis moisture, we can calculate the amount of water present in any weight of peppers having the same moisture content.

For example: 125 kg of peppers at 91.6% moisture would contain

$$125 \text{ kg} \times 0.916 = 114.5 \text{ kg of water} \quad (0.916 \text{ is } 91.6\% \text{ as a decimal})$$

$$\text{and: } 125 \text{ kg} \times 0.084 = 10.5 \text{ kg of dry solids} \quad (0.084 \text{ is } 8.4\% \text{ as a decimal})$$

$$\begin{aligned}\text{or: Weight of dry solids} &= \text{total weight} - \text{weight of water} \\ &= 125 \text{ kg total weight} - 114.5 \text{ kg of water} \\ &= 10.5 \text{ kg of dry solids}\end{aligned}$$

Table 7-1 shows some representative examples of wet basis moistures of other foods. Actual moisture contents may vary with varieties, locations in which they are grown, and growing conditions.

Table 7-1: Wet Basis Moisture Contents of Selected Materials

Material	Wet Basis Moisture (% by Weight)
Celery	95.4%
Tomatoes	94%
Strawberries	90%
Peaches	89%
Carrots	89%
Papaya	87%
Mangoes	85%
Apples	84%
Pineapple	84%
Potatoes	78%
Green Peas	74%
Yams	69%
Cassava	65%
Plantain	60%

7.2.2 Dry Basis Moisture:

The second method of expressing how much water is present in a material is “dry basis moisture”. Although it is not as commonly used as the “wet basis moisture”, it is much more important in most drying-related calculations.

To calculate the dry basis moisture, you need to divide the amount of water present in a sample by the weight of dry material present in that sample.

$$\text{Dry Basis Moisture} = \frac{\text{Weight of Water in the Sample}}{\text{Weight of Solids in the Sample}} \quad (\text{Eq'n 7-3})$$

The units associated with this calculation will be “grams of water per gram of dry solids” or “kg of water per kg of dry solids”, or some similar set of dimensions with the weight of water per unit weight of dry solids.

Since we are dealing with food products which generally contain only water and dry material, we can say:

$$\text{Total Weight of Material} = \text{Weight of Water} + \text{Weight of Dry Solids} \quad (\text{Eq'n 7-4})$$

Sample Calculation 7-2:

In our previous sample calculation (see Sample Calculation 7-1) involving the wet basis moisture content of a pepper sample, we had 175.2 grams of pepper slices containing 160.5 grams of water. Let's calculate its dry basis moisture.

First, we need to find the weight of dry solids present in the sample. (use equation 7-4)

$$\text{If: Total Weight of Material} = \text{Weight of Water} + \text{Weight of Dry Solids}$$

$$\begin{aligned} \text{Then: Weight of Dry Solids} &= \text{Total Weight of Material} - \text{Weight of Water} \\ &= 175.2 \text{ grams total weight} - 160.5 \text{ grams of water} \\ &= 14.7 \text{ grams of dry solids} \end{aligned}$$

$$\begin{aligned} \text{Recall (from Eq'n 7-3): Dry Basis Moisture} &= \frac{\text{Weight of Water in the Sample}}{\text{Weight of Solids in the Sample}} \\ &= \frac{160.5 \text{ g water}}{14.7 \text{ g solids}} \\ &= 10.92 \text{ g water / g dry solids} \end{aligned}$$

Therefore, the dry basis moisture of the peppers is:
10.92 grams of water per gram of dry solids

This is the same as 10.92 kg of water per kg of dry solids.



7.3 Converting from Wet Basis to Dry Basis Moisture:

In most drying-related calculations, we need to have the dry basis moisture. However, moisture contents are usually given on a wet basis. Fortunately, the conversion from wet basis moisture value to its corresponding dry basis moisture is not really too difficult. The key to doing the conversion is understanding what is meant by “wet basis” and “dry basis”.

“Wet basis” moistures tell us the weight of water as a percentage of the total weight of a sample. In order to calculate a “dry basis” moisture, we need the weight of water contained in a given weight of dry solids. Recognizing how these two are linked together is the key to doing the conversion from wet basis to dry basis moistures.

General Approach:

To convert from wet basis moistures to dry basis moistures, you may want to use the following approach:

1. Assume you have 100 grams of starting material.
2. Calculate the weight of water in 100 grams of starting material (i.e., $100 \text{ g} \times \% \text{ water as a decimal}$)
3. Calculate the weight of dry solids in 100 g of starting material. (i.e., $100 \text{ g} - \text{weight of water}$; or $100 \text{ g} \times \% \text{ solids as a decimal}$)
4. Divide the weight of water in grams by the weight of dry solids in grams.
5. The result will be grams of water per gram of dry solids.
6. The result obtained in step 5 will be equivalent to kilograms of water per kilogram of dry solids, or any other dimensionally consistent set of weight units.

Sample Calculation 7-3:

Let's consider a sample of potatoes with 78.0% wet basis moisture (from Table 7-1). To convert this value to its corresponding dry basis moisture, we need the weight of water contained by a given weight of dry solids.

We know that: $\% \text{ wet basis moisture} + \% \text{ solids by weight} = 100\%$

from which we can get: $\% \text{ solids by weight} = 100\% - \% \text{ wet basis moisture}$

For the potatoes: $\% \text{ solids by weight} = 100.0\% - 78.0\%$
 $= 22.0\%$

This doesn't actually give us the weight of water and solids that we need; but we are getting closer to it. The first thing that we need is a weight for the potatoes.

Since no weight is given, let's assume that we have 100.0 grams of potatoes. Any weight would work, but 100.0 grams is a very convenient number with which to work.

Therefore, 78.0% of their weight will be water and 22.0% of their weight will be dry solids.

From this we can get:

$$\begin{aligned} \text{Weight of water} &= 100.0 \text{ grams} \times 0.78 && \text{(i.e., 78\% as a decimal)} \\ &= 78.0 \text{ grams} \end{aligned}$$

$$\begin{aligned} \text{Weight of solids} &= 100.0 \text{ grams} \times 0.22 && \text{(i.e., 22\% as a decimal)} \\ &= 22.0 \text{ grams} \\ &\text{(or: } 100 \text{ g total} - 78.0 \text{ g water} = 22.0 \text{ g solids)} \end{aligned}$$

$$\begin{aligned} \text{Dry Basis Moisture} &= \frac{\text{Weight of Water in the Sample}}{\text{Weight of Solids in the Sample}} \\ &= \frac{78.0 \text{ g water}}{22.0 \text{ g solids}} \\ &= 3.55 \text{ g water / g dry solids} \end{aligned}$$

Sample Calculation 7-4:

Let's take a look at a "real-life" example of potatoes being dried.

Typically, the potatoes are peeled and boiled prior to drying in order to gelatinize the starch which makes it digestible by humans. The cooked potatoes can then be mashed and dried to make potato flakes, which are an example of how drying can be used to create a highly convenient product. If the consumer needs to make mashed potatoes quickly, the dried potato flakes can be easily mixed with the recommended amount of milk and boiling water. The result is a high quality product that takes much less time to prepare than if the potatoes had to be peeled, sliced, boiled, and mashed.

The potato in Figure 7-1 weighed 385.6 grams after peeling, and was going to be dried. Its moisture content was 78% on a wet basis.

- a. What weight of totally dry potato flakes would be obtained?
- b. What weight of product would be obtained if the potato flakes contained 5.84% moisture on a wet basis?

We will assume that no moisture is added to the potato during the time it is being boiled, and that no solids are lost while the potato is being processed.



Figure 7-1: Potato flakes obtained from drying 385.6 g of peeled potato

Solution to Part a:

$$\text{Weight of water in potato at start} = 385.6 \text{ g} \times 0.78 = 300.8 \text{ g}$$

$$\begin{aligned}\text{Weight of solids in potato at start} &= \text{weight of potato} - \text{weight of water} \\ &= 385.6 \text{ g} - 300.8 \text{ g} \\ &= 84.8 \text{ g}\end{aligned}$$

$$\begin{aligned}\text{or: \% solids} &= 100\% - \% \text{ water} \\ &= 100\% - 78\% \\ &= 22\%\end{aligned}$$

$$\text{Weight of solids at start} = 385.6 \text{ g} \times 0.22 = 84.8 \text{ g}$$

Therefore, the peeled potato contained 84.8 grams of dry solids.

Solution to Part b:

The dried product contains 5.84% water on a wet basis and the weight of the solids present is 84.8 grams.

In order to calculate the weight of the final product containing the 5.84% water, we will need to use a bit of algebra.

First, the percentage of solids in the final product should be found.

$$\begin{aligned}\% \text{ solids in product} &= 100\% - \% \text{ water} \\ &= 100\% - 5.84\% \\ &= 94.16\%\end{aligned}$$

If we let the final weight of the product including the water be X grams, we can say that 94.16% of this weight is the weight of the solids.

$$\text{This means that: } 94.16\% \text{ of } X = 84.8 \text{ g}$$

$$\text{or: } 0.9416 X = 84.8 \text{ g}$$

$$\text{Solving for X: } X = \frac{84.8 \text{ g}}{0.9416} = 90.06 \text{ g} \approx 90.1 \text{ g}$$

Therefore, we would obtain approximately 90.1 grams of potato flakes with 5.84% moisture from 385.6 grams of initial peeled potato.

Note: The potato flakes shown in Figure 7-1 weigh 90.1 grams.

7.4 Converting from Dry Basis to Wet Basis Moisture:

Since most people are accustomed to describing the moisture content of a food product as a percentage moisture on a wet basis, many of them have difficulty with dry basis moisture values. Recognizing this, we may need to change dry basis moisture values to their corresponding wet basis moisture equivalent.

Sample Calculation 7-4:

Consider a food material with a dry basis moisture content of 8.09 grams of water per gram of dry solids. What is its wet basis moisture content?

To solve this problem, we need to know the definition of wet basis moisture.

$$\% \text{ Wet Basis Moisture} = \frac{\text{Weight of Water in the Sample}}{\text{Total Weight of the Sample}} \times 100\%$$

From this definition, we can see that we need the weight of water present in the total weight of sample. From the given dry basis moisture, we have a weight of water, but we seem to be lacking the weight of the total sample.

However, if you consider things more closely, you will notice that we have 8.09 grams of water held by one gram of dry solids.

This means that the total weight of the sample is equal to the 8.09 grams of water plus the 1.00 grams of dry solids. Therefore, the total weight of the sample is 9.09 grams.

$$\begin{aligned} \% \text{ Wet Basis Moisture} &= \frac{8.09 \text{ g of water in the sample}}{9.09 \text{ g total weight of the sample}} \times 100\% \\ &= 89.0\% \end{aligned}$$

Therefore, the product has a wet basis moisture content of 89.0%

7.5 Comparing Wet Basis and Dry Basis Moistures:

The previous examples have provided some insight into how to convert from wet basis to dry basis moistures and from dry basis to wet basis moistures. Now would seem like an appropriate time to compare wet basis moistures to their equivalent dry basis moistures in a more visual form, using a graph of wet basis moisture versus dry basis moisture.

Figure 7-2 shows a graph prepared by taking a series of wet basis moistures and plotting them against their calculated equivalent dry basis moisture.

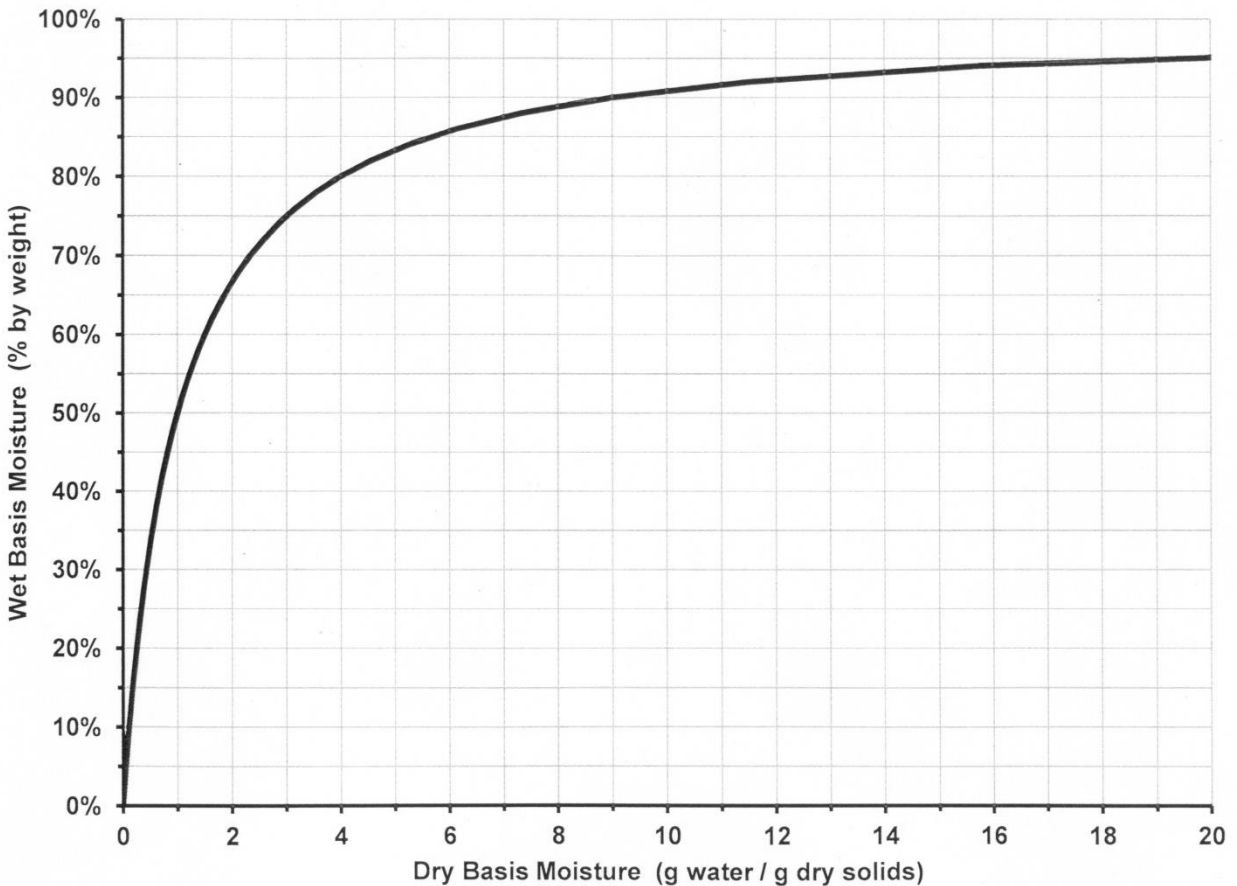

Figure 7-2: Wet basis moisture versus equivalent dry basis moisture

Perhaps the most noticeable trend in Figure 7-2 is that the relationship between the wet and dry basis moistures is not linear. The curve rises sharply during its initial stages and then levels off after the wet basis moisture reaches about 90%.

This lack of a linear relationship can create a great deal of confusion. Taking a slightly different view of Figure 7-2 may help show where this confusion can occur.

Figure 7-3 shows a portion of Figure 7-2 in more detail.

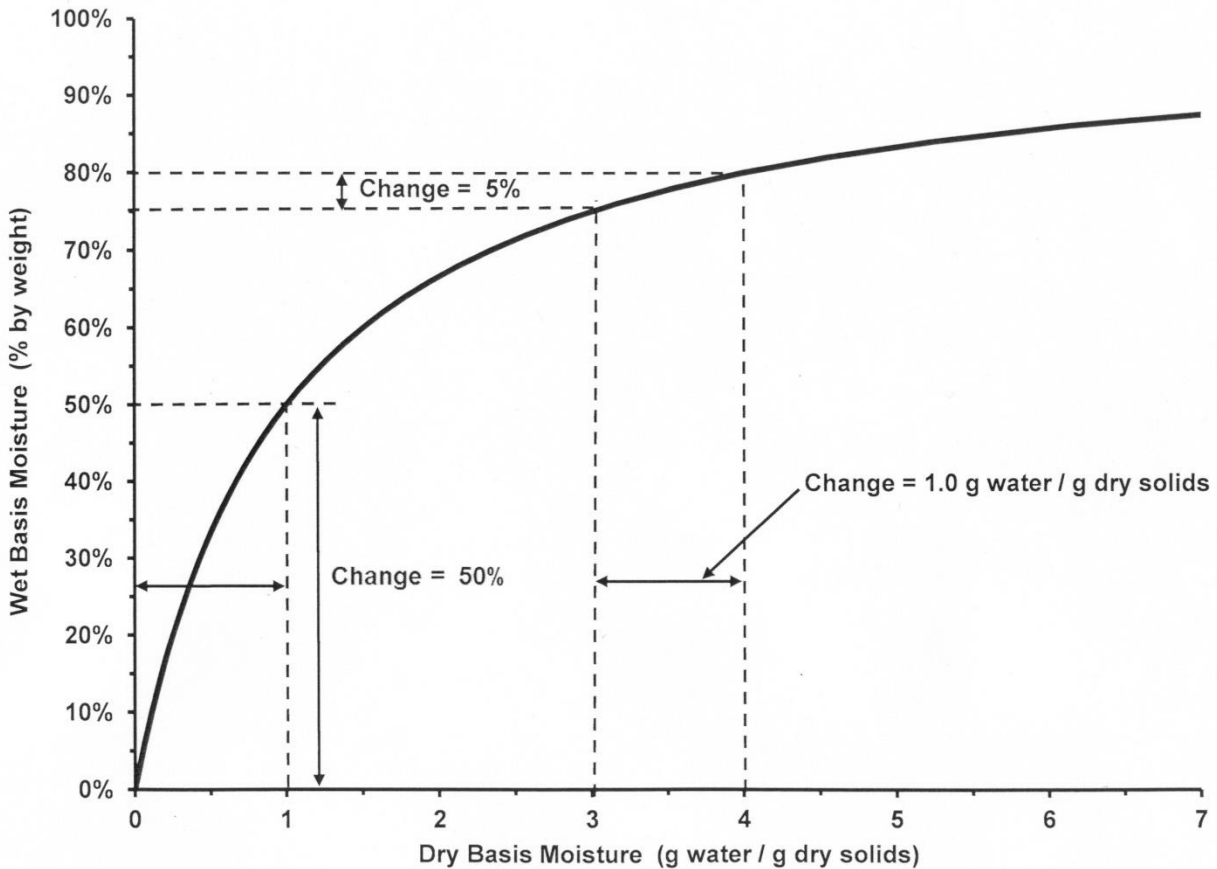

Figure 7-3: Relationships between wet basis and dry basis moistures

If we start with totally dry, or “bone dry”, material, there will be no water per gram of dry solids. The wet basis moisture will naturally be 0% water.

If we add 1.0 gram of water to 1.0 gram of dry solids, the wet basis moisture will be:

$$\begin{aligned} \% \text{ Wet Basis Moisture} &= \frac{1.0 \text{ g of water in the sample}}{2.0 \text{ g total weight of the sample}} \times 100\% \\ &= 50.0\% \end{aligned}$$

Adding 1.0 gram of water to 1.0 gram of dry solids increased the wet basis moisture by 50%.

At 75% wet basis moisture, there are 3.0 grams of water per 1.0 gram of dry solids.

If we add 1.0 gram of water to this, there will now be 4.0 grams of water per gram of dry solids. We will now have 4.0 grams of water in the sample and the total sample weight will be 5.0 grams (i.e., 4.0 grams of water + 1.0 gram of dry solids = 5.0 grams total).

The wet basis moisture will be:

$$\begin{aligned}\% \text{ Wet Basis Moisture} &= \frac{4.0 \text{ g of water in the sample}}{5.0 \text{ g total weight of the sample}} \times 100\% \\ &= 80.0\%\end{aligned}$$

Adding 1.0 gram of water at this point increased the wet basis moisture by only 5%, compared to 50% in the case where we went from 0 grams of water per gram of dry solids to 1.0 gram of water per gram of dry solids.

Sample Calculation 7-5:

Even though it is not shown in Figure 7-3, what would happen to the wet basis moisture if we had a very moist material with 15.0 grams of water per gram of dry solids and added 1.0 gram of water to give us 16.0 grams of water per gram of dry solids?

For 15.0 grams of water per gram of dry solids, the wet basis moisture will be:

$$\begin{aligned}\% \text{ Wet Basis Moisture} &= \frac{15.0 \text{ g of water in the sample}}{16.0 \text{ g total weight of the sample}} \times 100\% \\ &= 93.75\%\end{aligned}$$

For 16.0 grams of water per gram of dry solids, the wet basis moisture will be:

$$\begin{aligned}\% \text{ Wet Basis Moisture} &= \frac{16.0 \text{ g of water in the sample}}{17.0 \text{ g total weight of the sample}} \times 100\% \\ &= 94.12\%\end{aligned}$$

The change in wet basis moisture due to the addition of this 1.0 gram of water is only 0.37% (i.e., 94.12% - 93.75% = 0.37%).

Explaining the confusion:

Far too often, people forget that the relationship between wet basis moistures and dry basis moistures is not linear. They think if you remove a given amount of water from a relatively dry material that you will get the same change in wet basis moisture that you would get if you removed the exact same amount of water from a much more moist material. We have shown that this is not the case. Table 7-2 shows the changes in wet basis moisture (as a % by weight) that result from a reduction in the dry basis moisture by 1 gram of water per gram of dry solids.

A similar thing often happens when individuals consider reductions in the wet basis moisture contents of materials. From my personal experience, process operators have told me that the same amount of water must be removed from a material with a starting wet basis moisture of 80% to get to 75% moisture as would have to be removed at from a material with an initial wet basis moisture of 15% to get to 10%. Their logic is quite simply that both moisture reductions involve a change of 5% on a wet basis.

Table 7-2: Changes in wet basis moistures resulting from a 1 gram of water per gram of dry solid change in the dry basis moisture of a material

Dry Basis Moisture (grams of water /gram of dry solids)			Wet Basis Moisture (% by weight)		
Start	End	Change	Start	End	Change
20	19	1	95.24 %	95.00 %	0.24 %
19	18	1	95.00 %	94.74 %	0.26 %
18	17	1	94.74 %	94.44 %	0.29 %
17	16	1	94.44 %	94.12 %	0.33 %
16	15	1	94.12 %	93.75 %	0.37 %
15	14	1	93.75 %	93.33 %	0.42 %
14	13	1	93.33 %	92.86 %	0.48%
13	12	1	92.86 %	92.31 %	0.55%
12	11	1	92.31 %	91.67 %	0.64%
11	10	1	91.67 %	90.91 %	0.76%
10	9	1	90.91 %	90.00 %	0.91%
9	8	1	90.00 %	88.89 %	1.11%
8	7	1	88.89 %	87.5 %	1.39%
7	6	1	87.50 %	85.71 %	1.79%
6	5	1	85.71 %	83.33 %	2.38%
5	4	1	83.33 %	80.00 %	3.33%
4	3	1	80.00 %	75.00 %	5.00%
3	2	1	75.00 %	66.67 %	8.33%
2	1	1	66.67 %	50.00 %	16.67%
1	0	1	50.00 %	0.00 %	50.00%

7.6 Calculating the Amount of Water and Solids that are Present:

We have already touched on this briefly in the section on “Wet Basis Moisture” above. However, it is important to make special mention of this since so much depends upon it in most drying-related calculations.

Typically, you will have a given weight of starting material and need to calculate how much water must be removed to reach a desired final moisture; or some similar scenario. We will examine the calculation of the amount of water to be removed later in this chapter.

Sample Calculation 7-6:

A processor has 890 kg of mangoes with a moisture content of 85% on a wet basis. Calculate the weight of water and solids present.

$$\begin{aligned}\text{Weight of water} &= \text{Weight of material} \times \text{percentage water as a decimal} \\ &= 890 \text{ kg} \times 0.85 \\ &= 756.5 \text{ kg}\end{aligned}$$

$$\begin{aligned}\% \text{ Solids} &= 100\% - \% \text{ Water} \\ &= 100\% - 85\% \\ &= 15\%\end{aligned}$$



$$\begin{aligned}\text{Weight of solids} &= \text{Weight of material} \times \text{percent solids as a decimal} \\ &= 890 \text{ kg} \times 0.15 \\ &= 133.5 \text{ kg}\end{aligned}$$

Therefore, there are 756.5 kg of water and 133.5 kg of solids (i.e., dry solids) present.

You could also calculate the weight of the solids in the following manner:

$$\begin{aligned}\text{Weight of solids} &= \text{Total weight} - \text{Weight of water present} \\ &= 890 \text{ kg} - 756.5 \text{ kg} \\ &= 133.5 \text{ kg} \quad (\text{which is the same as calculated previously})\end{aligned}$$

Sample Calculation 7-7:

A processor has 1,525 kg of product with a dry basis moisture content of 6.5 grams of water per gram of dry solids. What are the weights of water and dry solids present?

This is where a wet basis moisture content would help us tremendously, so let's convert the dry basis moisture content to its equivalent wet basis moisture.

$$\begin{aligned}\text{Weight of sample} &= \text{Weight of water} + \text{weight of solids} \\ &= 6.5 \text{ grams of water} + 1.0 \text{ grams of dry solids} \\ &= 7.5 \text{ grams total}\end{aligned}$$

$$\begin{aligned}\% \text{ Wet Basis Moisture} &= \frac{6.5 \text{ g of water in the sample}}{7.5 \text{ g total weight of the sample}} \times 100\% \\ &= 86.7\%\end{aligned}$$

Note: Do not get confused here. We are using the grams of water per gram of dry solids only as a method of finding the wet basis moisture. We are not using grams in the overall calculation.

$$\begin{aligned}\text{Weight of water} &= \text{Weight of material} \times \text{percentage water as a decimal} \\ &= 1,525 \text{ kg} \times 0.867 \\ &= 1,322 \text{ kg}\end{aligned}$$

$$\begin{aligned}\% \text{ Solids} &= 100\% - \% \text{ Water} \\ &= 100\% - 86.7\% \\ &= 13.3\%\end{aligned}$$

$$\begin{aligned}\text{Weight of solids} &= \text{Weight of material} \times \text{percent solids as a decimal} \\ &= 1,525 \text{ kg} \times 0.133 \\ &= 203 \text{ kg}\end{aligned}$$

Therefore, there are 1,322 kg of water and 203 kg of solids (i.e., dry solids) present.

A quick way to check the validity of your answer is to add the weights of the water and solids and see if they total the starting weight of the material.

7.7 Calculating the Amount of Water to be Removed:

Quite often, it is necessary to calculate how much water must be removed from a given amount of starting material to reach a desired final moisture content. The following calculation explains how this can be done.

Sample Calculation 7-8:

A processor has 825 kg of mango slices with a moisture content of 85% (wet basis). Calculate how much water must be removed to dry the mango slices to a final moisture content of 10% (wet basis). How much final product will be obtained?

The first thing to do when faced with a problem of this nature is to draw a simple diagram. It will help organize the information that is provided, and identify what needs to be determined. It will also force you to take the time to plan your approach to solving the problem rather than rushing into it without the proper amount of consideration for what it is that you really need to do.

Figure 7-4 shows 825 kg of mangoes with 85% moisture being fed into a dryer. The product leaving the dryer has 10% moisture on a wet basis. From the diagram, it is easy to see that we do not know how much water is removed and how much product is leaving the dryer.

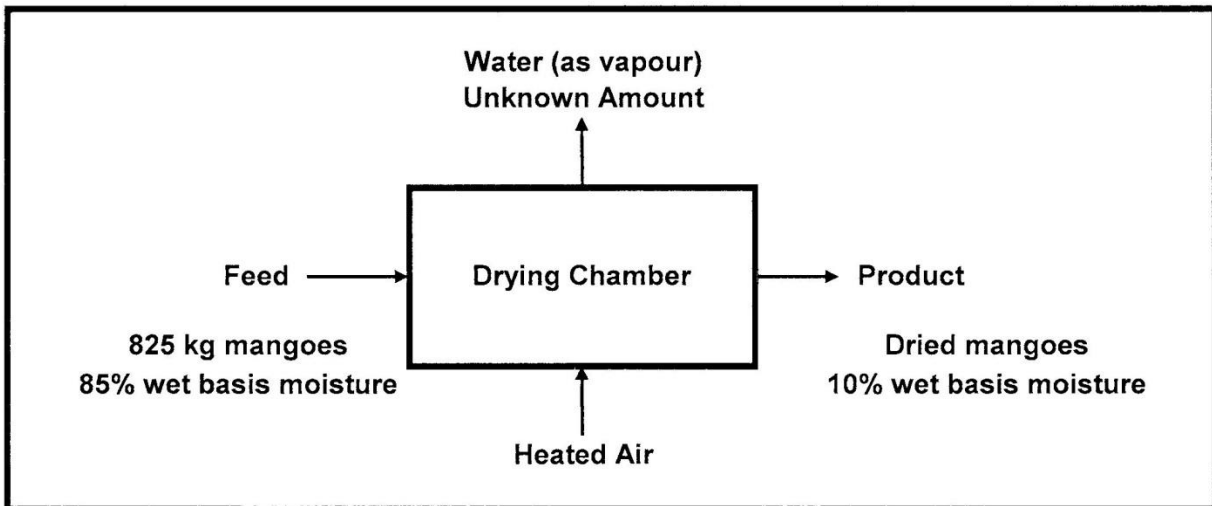

Figure 7-4: Diagram for Sample Calculation 7-8

You should start by finding the weights of water and dry solids present in the initial material. This is always a safe place to begin.

$$\begin{aligned}\text{Weight of water at start} &= \text{weight of mangoes at start} \times \text{moisture content} \\ &= 825 \text{ kg} \times 0.85 \quad (\text{i.e., 85\% as a decimal}) \\ &= 701.25 \text{ kg}\end{aligned}$$

$$\begin{aligned}\% \text{ solids at start} &= 100\% - \% \text{ water at start} \\ &= 100\% - 85\% \\ &= 15\%\end{aligned}$$

$$\begin{aligned}\text{Weight of solids at start} &= \text{weight of mangoes at start} \times \text{solids content} \\ &= 825 \text{ kg} \times 0.15 \quad (\text{i.e., 15\% as a decimal}) \\ &= 23.75 \text{ kg}\end{aligned}$$

In these cases, we will carry extra decimal places and round off the final answer.

The only thing that is known about the final product is that it has a wet basis moisture content of 10% (by weight). We do not know the weight of the final product.

In order to find the weight of the final product, we will make a simplifying assumption that there are no solids lost in the drying process. This is a safe assumption since drying tends to be a gentle process with only moisture removed in most cases. If there had been any solids lost in the drying process, we would need to be informed of these losses.

If no solids are lost in the drying process, we can say:

$$\text{Weight of solids in the final product} = \text{Weight of solids in the starting material}$$

This gives us 123.75 kg of dry solids in the final product.

Since the final product contains 10% moisture by weight, it will contain 90% solids.

Let X kg be the weight of the final product.

90% of X kg will be the weight of the solids in the final product.

$$0.90 X = 123.75 \text{ kg} \quad (\text{i.e., weight of dry solids in final product})$$

$$X = \frac{123.75 \text{ kg}}{0.9} = 137.5 \text{ kg}$$

$$\begin{aligned}\text{Weight of water in final product} &= \text{Weight of final product} - \text{Weight of solids} \\ &= 137.5 \text{ kg total weight} - 123.75 \text{ kg solids} \\ &= 13.75 \text{ kg}\end{aligned}$$

$$\begin{aligned}\text{Weight of water removed} &= \text{Weight of water at start} - \text{Weight of water at end} \\ &= 701.25 \text{ kg} - 13.75 \text{ kg} \\ &= 687.5 \text{ kg}\end{aligned}$$

Therefore, 687.5 kg of water have to be removed in the drying process.

and:

137.5 kg of dried mangoes would be obtained.

You could also say:

$$\begin{aligned}\text{Weight of water removed} &= \text{Weight of initial material} - \text{Weight of final product} \\ &= 825 \text{ kg} - 137.5 \text{ kg} \\ &= 687.5 \text{ kg}\end{aligned}$$

This is true because only water is being lost, so the difference between the starting weight and the final weight is equal to the amount of water removed.

7.8 Calculating the Amount of Starting Material to Give a Desired Amount of Product:

This calculation is essentially the reverse of the previous calculation. Here, we know how much final product we need. We must calculate the amount of starting material that would be required.

It cannot be emphasized enough that all of the calculations pertaining to food drying involve following the water and solids throughout the entire process. Please keep that in mind as you follow these sample calculations.

Sample Calculation 7-9:

In this example, a processor needs 150 kg of dried tomatoes with a final moisture content of 11% wet basis. The ripe tomatoes used for drying have a moisture content of 94% wet basis.

Once again, we will start with a simple diagram to organize the given information and identify what we need to determine to solve the problem (see Figure 7-5).

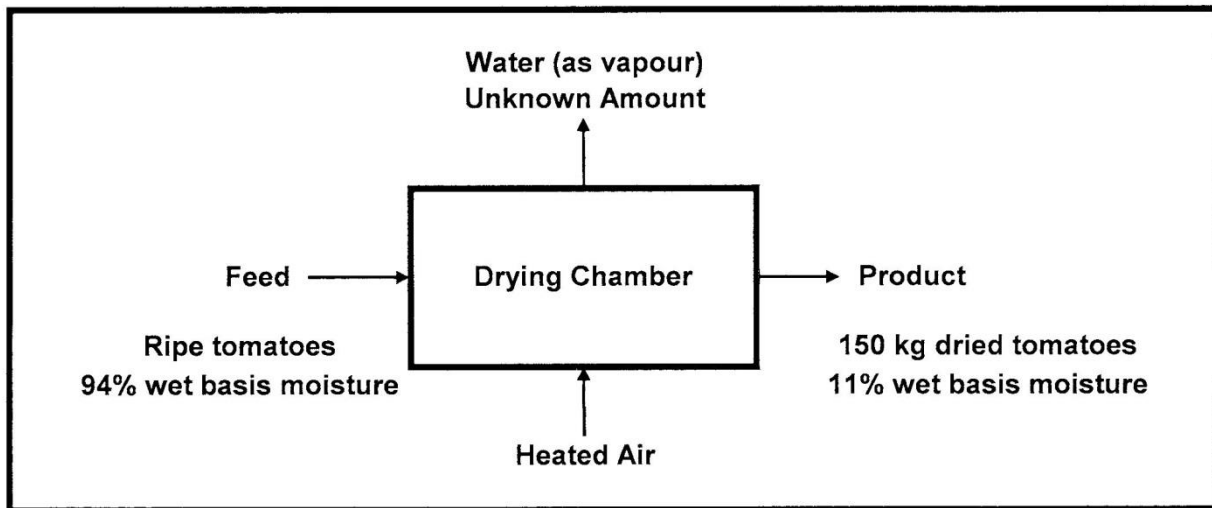

Figure 7-5: Diagram for Sample Calculation 7-9

We can then begin our problem solving by finding the weight of water and solids in the dried tomatoes.

$$\begin{aligned}\text{Weight of water in product} &= 150 \text{ kg} \times 0.11 \quad (\text{i.e., 11\% as a decimal}) \\ &= 16.5 \text{ kg}\end{aligned}$$

$$\begin{aligned}\% \text{ solids in product} &= 100\% - \% \text{ water in product} \\ &= 100\% - 11\% \\ &= 89\%\end{aligned}$$

$$\begin{aligned}\text{Weight of solids in product} &= 150 \text{ kg} \times 0.89 \quad (\text{i.e., 89\% as a decimal}) \\ &= 133.5 \text{ kg}\end{aligned}$$

Since there is no indication that any solids were lost in the drying process, we will assume that the weight of solids present in the starting material is the same as that present in the finished product.

$$\text{Weight of solids in starting material} = 133.5 \text{ kg}$$

$$\% \text{ water in starting material} = 94\% \quad (\text{given information})$$

$$\begin{aligned}\% \text{ solids in starting material} &= 100\% - \% \text{ water in starting material} \\ &= 100\% - 94\% \text{ water} \\ &= 6\% \text{ solids}\end{aligned}$$

Let X kg be the weight of tomatoes at the start

6% of the starting weight is solids, so 6% of X kg is equal to 133.5 kg of solids

$$0.06 X = 133.5 \text{ kg}$$

$$X = \frac{133.5 \text{ kg}}{0.06} = 2,225 \text{ kg}$$



Therefore, 2,225 kg of tomatoes with a moisture content of 94% (wet basis) are required to obtain 150 kg of dried tomatoes at 11% wet basis moisture.

7.9 Calculating the Amount of Starting Material to Give a Desired Amount of Product When there is a Loss of Solids in the Drying Process:

Here we have yet another possible drying scenario which you could encounter. It sometimes happens that material is lost during the drying process and we need to know how to handle the calculation to account for it.

Sample Calculation 7-10:

In this example calculation, we want to obtain 175 kg of dried peaches with a final moisture content of 12% on a wet basis. The initial moisture of the peaches is 89% (wet basis). Due to problems with dried product sticking to the surface of the drying racks, we can expect a loss of 5% of the finished product.

Figure 7-6 shows the diagram for organizing the given information. Notice that the 5% loss of finished product has been indicated by an arrow leaving the bottom of the drying chamber.

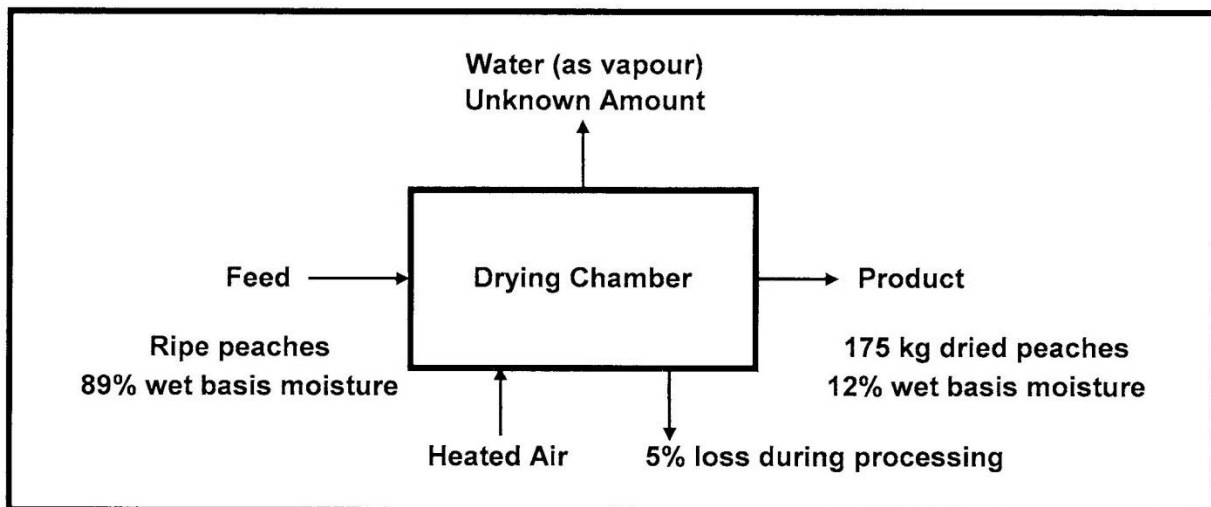

Figure 7-6: Diagram for Sample Calculation 7-10

The first thing we need to do is find the weight of finished product that will account for the 5% loss. If we have a 5% loss, this means that we will have a 95% yield of finished product. You must be careful to read the problem statement to be certain as to what is actually being lost. Here, we are losing some finished product, which would be dry material. In other cases, there could be a loss of raw material as it is fed to the dryer.

Let Y kg be the weight of finished product before the loss occurs.

$$0.95 Y = 175 \text{ kg of finished product}$$

$$\text{Solving for Y: } Y = \frac{175 \text{ kg}}{0.95} = 184.2 \text{ kg}$$

This means 184.2 kg of finished product are needed in order to get the desired 175 kg.

Let's calculate the weight of water and solids present:

$$\begin{aligned} \text{Weight of water} &= 184.2 \text{ kg} \times 0.12 && \text{(i.e., 12\% as a decimal)} \\ &= 22.1 \text{ kg} \end{aligned}$$

$$\begin{aligned} \% \text{ solids} &= 100\% - \% \text{ water} \\ &= 100\% - 12\% \\ &= 88\% \end{aligned}$$

$$\begin{aligned} \text{Weight of solids} &= 184.2 \text{ kg} \times 0.88 && \text{(i.e., 88\% as a decimal)} \\ &= 162.1 \text{ kg} \end{aligned}$$

We have already accounted for the loss of product, so we can now say that the weight of solids in the starting material must be 162.1 kg.

Let X kg be the weight of the starting material which has a moisture content of 89% by weight.

This means there will be 11% solids in the starting material
(i.e., 100% - 89% water = 11% solids)

$$\text{Therefore: } 0.11 X = 162.1 \text{ kg}$$

$$\text{Solving for X: } X = \frac{162.1 \text{ kg}}{0.11} = 1,473.6 \text{ kg}$$

Therefore, 1,473.6 kg of peaches are needed at the start of the process to give 175 kg of final dried product while accounting for the loss.

7-10 Practice Problems (with Answers):

Here are some problems relating to the material covered in this chapter. You may find them helpful in reviewing the various concepts we have examined. I have not worried about significant digits. The answers have usually been expressed to two decimal places which will allow you to follow the calculations more readily than if rounded values were reported. In real-life situations, it is almost impossible to achieve this accuracy.

1. Convert the following wet basis moistures to their equivalent dry basis moistures. Express your answers to two decimal places and include appropriate dimensions.

87.9 %	(Answer = 7.26 g water / g dry solids)
83.2 %	(Answer = 5.07 g water / g dry solids)
78.8 %	(Answer = 3.72 g water / g dry solids)
35.7 %	(Answer = 0.56 g water / g dry solids)

The answers can be expressed with any units of weight divided by similar weight units (e.g., kg water / kg dry solids etc.)

2. Convert the following dry basis moistures to their equivalent wet basis moistures. Express your answers to two decimal places and remember to include the % sign.

15.35 g water / g dry solids	(Answer = 93.88 %)
8.43 g water / g dry solids	(Answer = 89.40 %)
6.27 g water / g dry solids	(Answer = 86.24 %)
2.67 g water / g dry solids	(Answer = 72.75 %)

3. During a drying process, the dryer operator takes a small sample of the material and checks it for its moisture content. She finds that the wet basis moisture is 71.5% by weight. 87.0 kg of material with a moisture content of 89% by weight was originally placed in the dryer. How much water has been removed up to this time? What is the weight of the material left in the dryer at the time the sample was taken?

(Answer: At start we have 77.43 kg of water and 9.57 kg of solids in the feed material. When the sample was taken, there would be 9.57 kg of solids and 24.00 kg of water in the remaining material. This gives us a moisture removal of 53.43 kg of water. There would be 33.57 kg of material left in the dryer at the time the sample was taken.)

4. How much water needs to be removed from 125.7 kg of papaya at 87.3% wet basis moisture to get a final dried product with 10.5% moisture? How much dried papaya would you obtain?

(Answer: There would be 109.74 kg of water and 15.96 kg of dry solids in the initial papaya. There would be 15.96 kg of solids in the dried papaya, at 10.5% moisture, which gives us 17.83 kg of dried material. It would contain 1.87 kg of water. This means that 107.87 kg of water would have to be removed.)

5. A processor has a contract to provide 750 kg of dried spices to a company that make dried pasta meals. To be sure of having enough dried material to fill the order, the dryer operator allows for a loss of 2.5% of the final dried spice blend.

The initial moisture content of the material going into the dryer is 84.5% and the desired final moisture content is 11.5%.

- a. How much starting material would be needed to fill this order?
- b. How much water must be removed from the starting material?
- c. If 50 kg of initial fresh spices can be dried in a single batch, how many batches of drying would be required?
- d. If a continuous dryer was used that could remove 150 kg of water per hour, how long would it take to process this order?

(Answers: a. You should let the amount of dried material before the losses be X kg. Solving for X, you will find that 769.23 kg of spices at 11.5% moisture are need to account for the loss. $0.975 X = 750 \text{ kg}$. The 769.23 kg of dried spices that need to be produced to account for the losses will contain 88.46 kg of water and 680.77 kg of solids. This means we need 680.77 kg of dry solids in the material at 84.5% moisture. The weight of material required will have to be 4,392.06 kg and 3,622.83 kg of water would have to be removed.

- b. The processor would need to run 87.84 batches, which would actually become 88 batches.
- c. The continuous dryer would have to be run for 24.15 hours, or about 24 hours.)

8. ADVANCED DRYING-RELATED CALCULATIONS

8.1 Introduction:

As a follow-up to the basic calculations pertaining to drying, this section provides instruction in how to deal with calculations relating to dryers themselves.

We will be looking at some dryer designs later in the manual. As we do this, there is one important basic concept that needs to be understood in order to work through the material presented here. This is the “water removal capacity of a dryer”.

8.2 Water Removal Capacity of Dryers:

When a dryer is built, it has the ability to remove a certain amount of water from a given product in a specified period of time. For example, a dryer might be able to remove 250 kg of water per hour when drying leafy herbs.

Similarly, a dryer might be constructed to dry a certain type of grain and may be capable of removing 1,000 kg of water per hour under a specific set of operating conditions.

Water removal capacities are a design feature that the supplier and customer decide upon before actually fabricating the dryer. It is based on the material being dried; the required amount of product per given amount of time; and the initial and final moisture contents of the material before and after drying.

The manufacturer may build the dryer to give a slightly higher water removal capacity, but this is not always the case.

Once the dryer is built and installed, it should be operated in accordance with its designed water removal capacity. However, this is frequently not the case. Processors often decide that they need to make more finished product, and they try to increase the amount of wet material put through the dryer on an hourly basis. The result of this practice is that the dryer cannot remove the extra moisture entering it and the final product has a moisture content that is too high.

**Chapter 8:
An Introduction to the Dehydration and
Drying of Fruits and Vegetables**

**Donald G. Mercer, Ph.D., P.Eng., FIAFoST
Department of Food Science
University of Guelph
Ontario, Canada
ISBN 978-0-88955-621-8
© 2014**

8.3 Calculating Dryer Feed Rates Based on Water Removal Capacities:

Suppose a company purchases a dryer to process herbs such as oregano. Based on previous experience and the demand for this product, the dryer has been designed with a water removal capacity of 250 kg of water per hour. The water content of the fresh oregano being dried is typically 87% on a wet basis (see Figure 8-1).

In this example, the dryer being used consists of a wire mesh conveyor belt that moves the oregano through a long drying chamber at a very slow speed. The belt moves so slowly that the material will be in the dryer for several hours.

Problem Statement: Calculate the weight of oregano that can be fed into the dryer per hour if the desired final moisture content is 10% (wet basis).

This will be the weight of the actual oregano leaves that are required at the start. There could be losses due to removing any heavy stems prior to drying.

The problem facing us is sufficiently complex that a diagram would help to clarify things significantly. Even the simplest diagram will force us to organize what we know; identify what we need to find; and establish how the various processing streams entering and leaving the dryer are related. Figure 8-2 shows how the initial information can be organized.



Figure 8-1: Oregano prior to drying

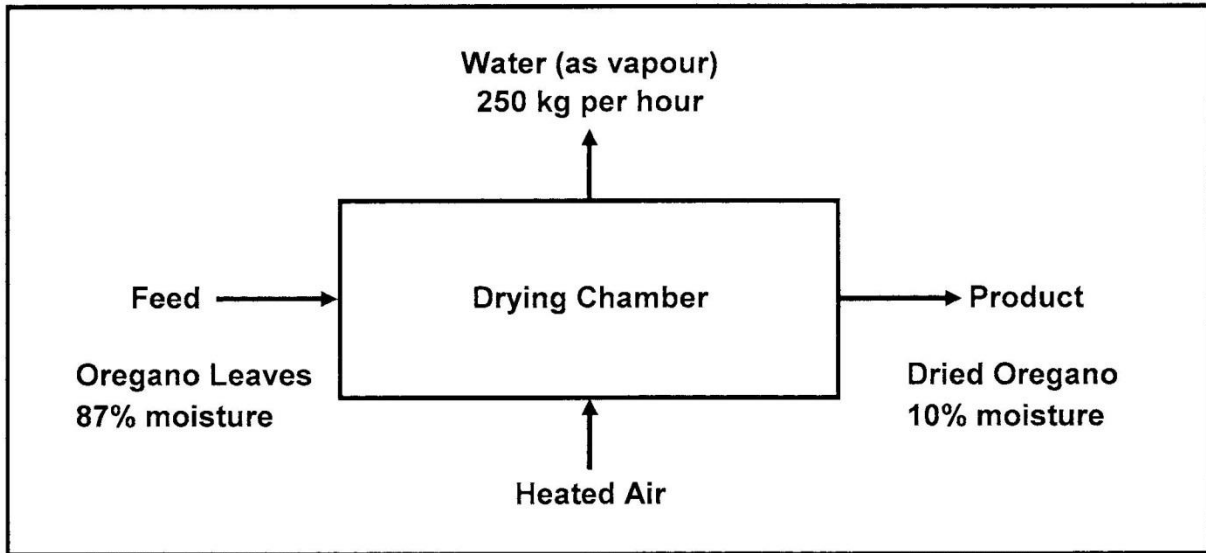

Figure 8-2: Initial information for the drying of oregano leaves problem

This situation appears to be a bit difficult to solve at first glance. However, we need to follow the weights of water and solids and find a point at which to begin our solution. It should be recognized that the weight of solids in the feed material will be the same as the weight of solids leaving the dryer in the product because there are no losses of solids during drying in this case. If we base our mathematical treatment on one hour of dryer operation, the weight of water in the product will be 250 kg less than the weight of water in the feed material. (Recall 250 kg per hour is the water removal capacity of the dryer).

Based on 1.0 hour of operation:

$$\text{Water in product} = \text{Water in feed} - 250 \text{ kg}$$

$$\text{Solids in product} = \text{Solids in feed}$$

$$\text{Weight of product} = \text{Weight of feed} - 250 \text{ kg}$$

Unfortunately, no weights of oregano leaves coming into the dryer, nor dried oregano coming out of the dryer, are given. However, using the relationships established in these three equations and some basic algebra, a solution to the problem is possible.

Let weight of solids in feed = X kg

It then follows that: X kg = Weight of solids in product

Looking at the feed material:

$$\begin{aligned}\% \text{ solids} &= 100\% - \% \text{ water} \\ &= 100\% - 87\% \\ &= 13\%\end{aligned}$$

$$\text{Weight of solids in feed} = \text{Weight of solids in product} = X \text{ kg}$$

$$\text{Therefore: } X \text{ kg} = 0.13 \times \text{Weight of feed}$$

$$\text{Weight of feed} = \frac{X \text{ kg}}{0.13}$$

Looking at the final product:

$$\begin{aligned}\% \text{ solids in product} &= 100\% - \% \text{ water in product} \\ &= 100\% - 10\% \\ &= 90\%\end{aligned}$$

This means that 90% of the product weight is solids.

$$\text{Therefore: } \text{Weight of solids} = X \text{ kg} = 0.90 \times \text{Weight of product}$$

$$\text{Weight of product} = \frac{X \text{ kg}}{0.90}$$

It is also known that:

$$\text{Weight of feed} = \text{Weight of product} + 250 \text{ kg of water removed}$$

$$= \frac{X \text{ kg}}{0.90} + 250 \text{ kg}$$

We now have two expressions for the weight of the feed material - both involving X.

We can equate these two expressions and solve for X:

$$\frac{X \text{ kg}}{0.90} + 250 \text{ kg} = \frac{X \text{ kg}}{0.13} = 7.69 X$$

$$\text{Multiplying both sides by 0.90 gives: } X + 225 \text{ kg} = 6.921 X$$

$$\text{Re-arranging this equation gives: } 225 \text{ kg} = 5.921 X$$

$$\text{Solving for X: } X = \frac{225 \text{ kg}}{5.921} = 38.00 \text{ kg}$$

Knowing that there are 38.0 kg of solids in the feed material and in the product allows us to calculate the weights of feed and product.

$$\text{Weight of feed material} = \frac{\text{Weight of solids}}{0.13} = \frac{38.0 \text{ kg}}{0.13} = 292.2 \text{ kg}$$

$$\text{Weight of product} = \frac{\text{Weight of solids}}{0.90} = \frac{38.0 \text{ kg}}{0.90} = 42.2 \text{ kg}$$

This rather lengthy and involved calculation tells us that if we have oregano with an initial moisture of 87% (wet basis), we can dry 292.2 kg of fresh material per hour and obtain 42.2 kg of product per hour with a moisture content of 10% (wet basis).

8.4 Calculations of Product Moisture Content When Exceeding Water Removal Capacity of a Dryer:

Looking at the dryer in the calculation above, we see that it had a water removal capacity of 250 kg of water per hour when oregano. If the oregano has a moisture content of 87% (wet basis) 292.2 kg can be fed to the dryer on an hourly basis. Once again, it is somewhat absurd to carry these weights to one or two decimal places. However, for the sake of this academic exercise we will do this and make it easier to follow the calculations without using rounded values.

Let's take a look at what would happen if the operator tried to get more product out of the dryer by putting a greater weight of oregano into the dryer each hour. For this example, we will say that the operator increases the feed rate to 300 kg of oregano per hour.

The first thing to do is calculate the weights of water and solids in the feed. We will base our calculations on one hour of operation.

$$\begin{aligned} \text{Weight of water in feed material} &= 300 \text{ kg} \times 0.87 = 261.0 \text{ kg} \\ \text{Weight of solids in feed material} &= 300 \text{ kg} \times 0.13 = 39.0 \text{ kg} \end{aligned}$$

Recall: The dryer has been designed to remove 250 kg of water per hour.

$$\begin{aligned} \text{Weight of water in product} &= \text{Weight of water in feed material} - 250 \text{ kg} \\ &= 261.0 \text{ kg} - 250 \text{ kg} \\ &= 11.0 \text{ kg} \end{aligned}$$

$$\text{Weight of solids in product} = \text{Weight of solids in feed material} = 39.0 \text{ kg}$$

$$\begin{aligned}\text{Total weight of product} &= \text{Weight of water} + \text{Weight of solids} \\ &= 11.0 \text{ kg} + 39.0 \text{ kg} \\ &= 50.0 \text{ kg}\end{aligned}$$

$$\begin{aligned}\% \text{ wet basis moisture} &= \frac{\text{Weight of water in material}}{\text{Total weight of material}} \times 100\% \\ &= \frac{11.0 \text{ kg water}}{50.0 \text{ kg total weight}} \times 100\% \\ &= 22.0\%\end{aligned}$$

Notice how increasing the weight of oregano in the feed to the dryer by only 7.8 kg per hour (i.e., from 292.2 kg/hour up to 300 kg/hour) resulted in the moisture content of the product jumping from 10% to 22%. The oregano leaving the dryer could possibly spoil, losing its characteristic taste and aroma, due to this elevated moisture level which is well beyond the processor's target of 10%.

8.5 The Impact of Changing Raw Material Moisture on Final Product Moisture Levels:

Sometimes the moisture content of the raw materials being dried can change slightly. While this may be accommodated by adjusting the drying conditions, there can be times when this is not possible.

Once again, we will consider the drying of oregano leaves in a dryer capable of removing 250 kg of water per hour. In our previous calculations, the dryer was operating at the limit of its water removal capacity with a feed rate of 292.2 kg per hour of oregano which had a moisture content of 87% (wet basis). Under these conditions, the final product had the desired final moisture content of 10% (wet basis).

Let's examine what would happen if a new batch of oregano leaves with a moisture content of 88% (wet basis) was used as feed material for the drying process. 292.2 kg of these leaves will be fed to the dryer on an hourly basis. Process operators often think that because the feed material moisture increased by 1.0% that the final product moisture will increase by the same amount. This is definitely not the case as we shall see.

A diagram similar to that for the original batch of oregano leaves (see Figure 8-2) can be drawn with only the moisture content of the feed changed and the moisture content of the final product left as an unknown. Such a diagram appears as Figure 8-3.

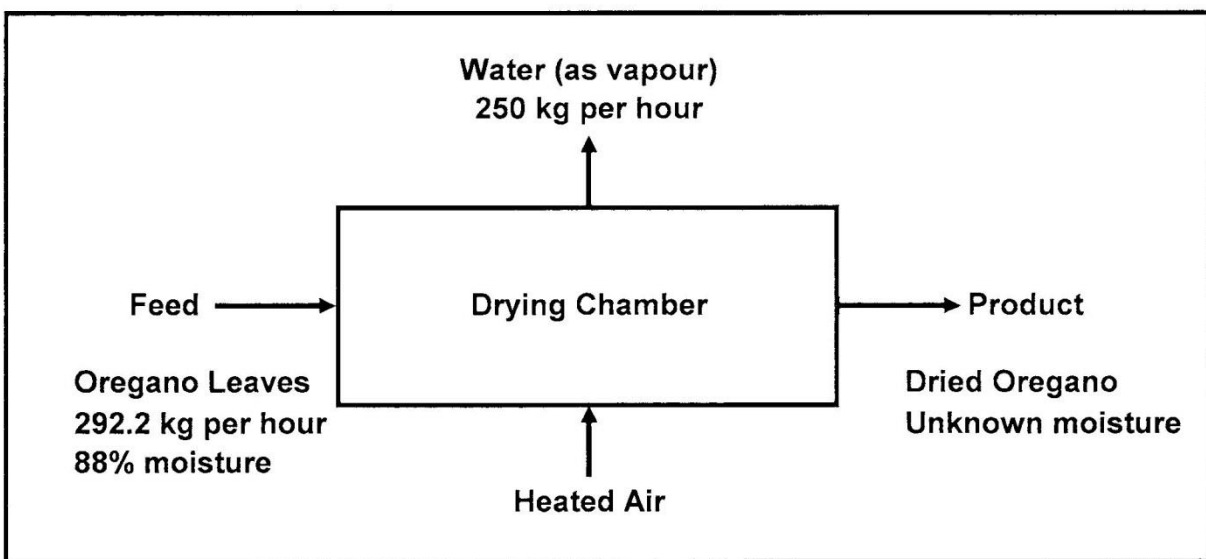

Figure 8-3: Drying of 292.2 kg/hour of oregano leaves with 88% moisture

As usual, we need to find the weights of water and solids present in the feed material. We can base our calculations on one hour of operation.

$$\begin{aligned}\text{Weight of water in feed material} &= 292.2 \text{ kg} \times 0.88 \\ &= 257.1 \text{ kg}\end{aligned}$$

$$\begin{aligned}\text{Weight of solids in feed material} &= 292.2 \text{ kg} \times 0.12 \quad (\text{i.e., 12\% solids}) \\ &= 35.1 \text{ kg}\end{aligned}$$

$$\text{Water removed from oregano per hour} = 250 \text{ kg} \quad (\text{capacity of the dryer})$$

$$\begin{aligned}\text{Water left in oregano after drying} &= \text{water in feed material} - 650 \text{ kg water} \\ &= 257.1 \text{ kg} - 250 \text{ kg} \\ &= 7.1 \text{ kg}\end{aligned}$$

$$\begin{aligned}\text{Weight of dried product} &= \text{weight of water left after drying} + \text{weight of solids} \\ &= 7.1 \text{ kg} + 35.1 \text{ kg} \\ &= 42.2 \text{ kg}\end{aligned}$$

$$\begin{aligned}\% \text{ wet basis moisture} &= \frac{\text{Weight of water in material}}{\text{Total weight of material}} \times 100\% \\ &= \frac{7.1 \text{ kg water}}{42.2 \text{ kg total weight}} \times 100\% \\ &= 16.8\%\end{aligned}$$

Therefore, an increase of 1.0% in moisture of the feed to the dryer resulted in a 6.8% increase in the final product moisture from its original 10% to 16.8%. Note that this was not a 1% increase as some dryer operators may have expected.

This may put the product outside the specified moisture limits which may be something like 10% plus or minus 2%. This would give an acceptable moisture range of 8% to 12% with a target of 10%.

8.6 Water Removal Rate Calculations Based on Experimental Results:

Those involved in drying most types of food, or even non-food products, are frequently interested in how fast their product is drying.

We have now looked at a variety of drying-based calculations which have been examined as separate operations. In “real-life” situations involving actual drying calculations, these are often linked together. Perhaps the best way to show this is through the use of some actual experimental data which we will then use as a basis for learning more about how the drying process is progressing.

In this experiment hot yellow pepper slices were prepared by slicing the peppers lengthwise into quarters and removing the seeds (see Figure 8-4). The slices were then placed on a wire mesh rack inside a dryer where air at 50°C was blown across them at a velocity of 0.5 metres per second. A balance assembly connected to the drying rack allowed the weight of the pepper slices to be taken at 15 minute intervals throughout the entire drying period. A laboratory balance capable of readings to a tenth of a gram was used to determine the initial weight of the pepper slices. Unfortunately, the balance on the dryer was only capable of reading to the nearest gram. However, this is not really a serious problem.



Figure 8-4: Hot yellow pepper sliced into quarters with seeds removed

Samples of the peppers were tested for their moisture content using a moisture balance. The wet basis moisture of the starting material was 93.0%. Initially, the weight of the pepper slices was 156.1 grams as shown as the first entry in the second column of Table 8-1 below. Weights of the peppers were recorded at 15 minute intervals. In the interest of brevity, only values for each one-hour interval have been inserted in the second column of the table for the first twenty hours of the drying run. After this time, there was very little change in the weight of the peppers, so the remaining weights have not been included here.

Table 8-1: Calculations Based on Data Collected from Drying of Quartered Hot Yellow Peppers

Column 1	Column 2	Column 3	Column 4	Column 5	Column 6
Delta t (hours)	Wt of Peppers (g)	Wt of Water (g)	Wt of Solids (g)	Wet Basis Moisture (%)	Dry Basis Moisture (g water/g solids)
0	156.1	145.17	10.93	93.00%	13.29
1	119	108.07	10.93	90.82%	9.89
2	96	85.07	10.93	88.62%	7.79
3	79	68.07	10.93	86.17%	6.23
4	66	55.07	10.93	83.44%	5.04
5	56	45.07	10.93	80.49%	4.12
6	48	37.07	10.93	77.24%	3.39
7	41	30.07	10.93	73.35%	2.75
8	36	25.07	10.93	69.65%	2.29
9	31	20.07	10.93	64.75%	1.84
10	27	16.07	10.93	59.53%	1.47
11	23	12.07	10.93	52.49%	1.10
12	21	10.07	10.93	47.97%	0.92
13	18	7.07	10.93	39.29%	0.65
14	16	5.07	10.93	31.71%	0.46
15	15	4.07	10.93	27.15%	0.37
16	14	3.07	10.93	21.95%	0.28
17	14	3.07	10.93	21.95%	0.28
18	13	2.07	10.93	15.95%	0.19
19	12	1.07	10.93	8.94%	0.10
20	12	1.07	10.93	8.94%	0.10

It may be tempting to simply plot the weight of the pepper slices versus time. This would not really be all that informative to someone who is not starting with a weight of 156.1 grams of peppers. Preparing a graph of the dry basis moisture content is generally recognized as a more informative way in which to show moisture losses during drying. Since dry basis moisture is defined as the weight of water per unit weight of dry solids, we will need to calculate the weight of water and solids present in the pepper slices at each time interval.

At the start of the drying process, the pepper slices had a moisture content of 93.0% (wet basis). The weight of water present in the initial sample put into the dryer was:

$$\begin{aligned}\text{Weight of water} &= \text{Weight of sample} \times \% \text{ water present} \\ &= 156.1 \text{ grams} \times 0.930 \\ &= 145.17 \text{ grams}\end{aligned}$$

This value appears as the first entry in the third column of the table.

The weight of dry solids can be calculated in two ways.

$$\begin{aligned}\text{Method 1: Weight of dry solids} &= \text{Weight of sample} - \text{Weight of water} \\ &= 156.1 \text{ grams} - 145.17 \text{ grams} \\ &= 10.93 \text{ grams}\end{aligned}$$

$$\begin{aligned}\text{Method 2: \% solids in sample} &= 100\% - \% \text{ water present} \\ &= 100\% - 93.0\% \\ &= 7.0\%\end{aligned}$$

$$\begin{aligned}\text{Weight of dry solids} &= \text{Weight of sample} \times \% \text{ solids present} \\ &= 156.1 \text{ grams} \times 0.070 \\ &= 10.93 \text{ grams}\end{aligned}$$

This value appears as the first entry in the fourth column of the table.

Since there were no losses of solids experienced in the drying process, the weight of solids remained constant throughout the entire time. Therefore, the weight of dry solids was repeated down the entire length of the fourth column in the table.

Knowing the weight of the sample at any time during the drying process and recognizing that the weight of dry solids was a constant value of 10.93 grams allows us to calculate the water content of the sample at any given time.

$$\text{Weight of water in sample} = \text{Weight of the sample} - \text{Weight of dry solids}$$

Using this relationship permits us to enter the weights of water in the remaining rows in the third column of the table, as shown.

Because many people think of drying in terms of the wet basis moisture of a material, this may also be included in the table.

$$\text{Wet basis moisture} = \frac{\text{Weight of water}}{\text{Total weight}} \times 100\%$$

The total weight of pepper slices appears in the second column of the table and the weight of water they contain is given in the third column. Applying these values to the equation above gives the wet basis moisture as shown in column five.

There is now enough information available to calculate the dry basis moisture, which is what we really want. Dividing the weight of water in the third column of the table by the weight of dry solids in the fourth column will give us the desired dry basis moistures as indicated in the sixth column of the table.

We can now plot the dry basis moisture versus time to see how the drying process is taking place. Figure 8-5 shows a plot of the data points for the dry basis moistures at all fifteen minute intervals up to 16 hours of drying.

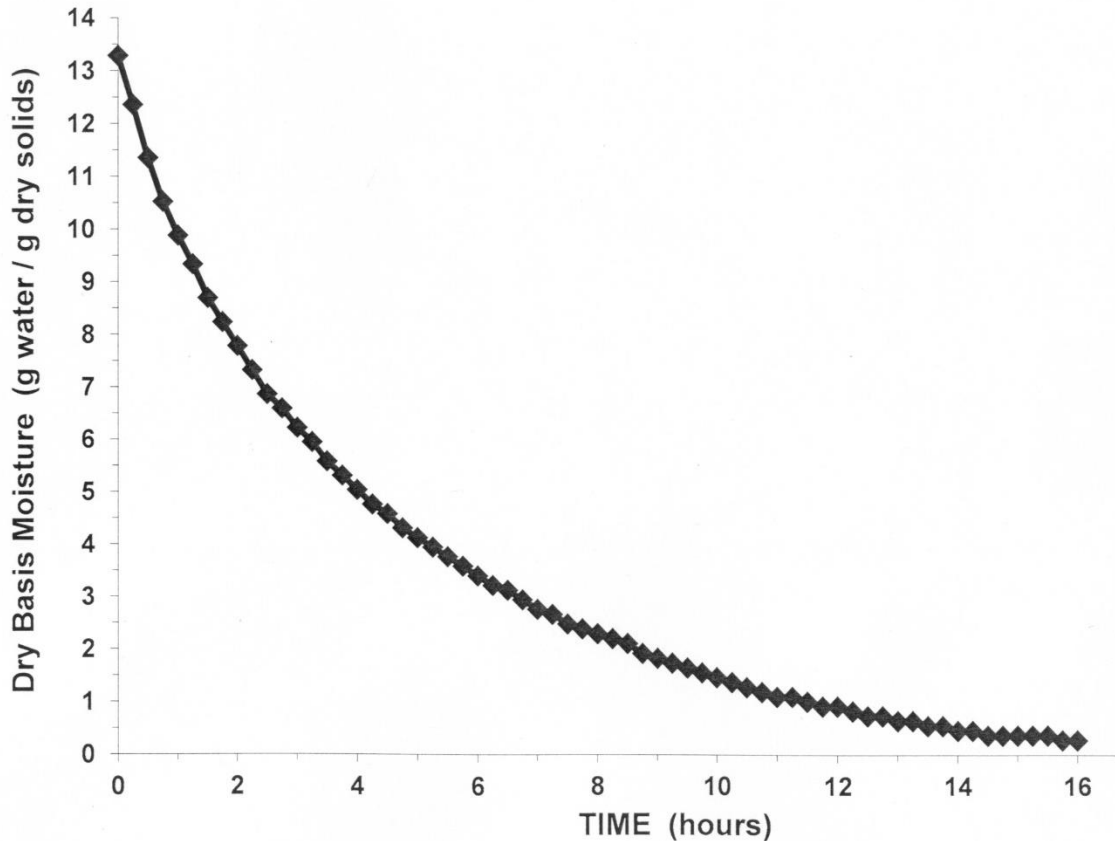

Figure 8-5: Dry moisture versus time for the drying of hot yellow peppers

In Figure 8-5, we can see that the curve begins with a reasonably straight section for about the first two hours or so. This means that the rate of moisture loss is relatively constant, which we know corresponds to the “constant rate drying period”. Here, the pepper slices have saturated surfaces with a pool of moisture that can be evaporated by the heated air moving across them. There is no “warm-up period” for the pepper slices, based on what we see in this graph.

To calculate the rate at which moisture is being removed during the “constant rate drying period”, we need to find the slope of the curve during the first two hours. Figure 8-6 shows how a straight, heavy dashed line has been drawn following the linear portion of the curve and extending well beyond it downwards to the right until it approaches the horizontal axis of the graph. The slope of this line will be equal to the water removal rate during the “constant rate drying period.”

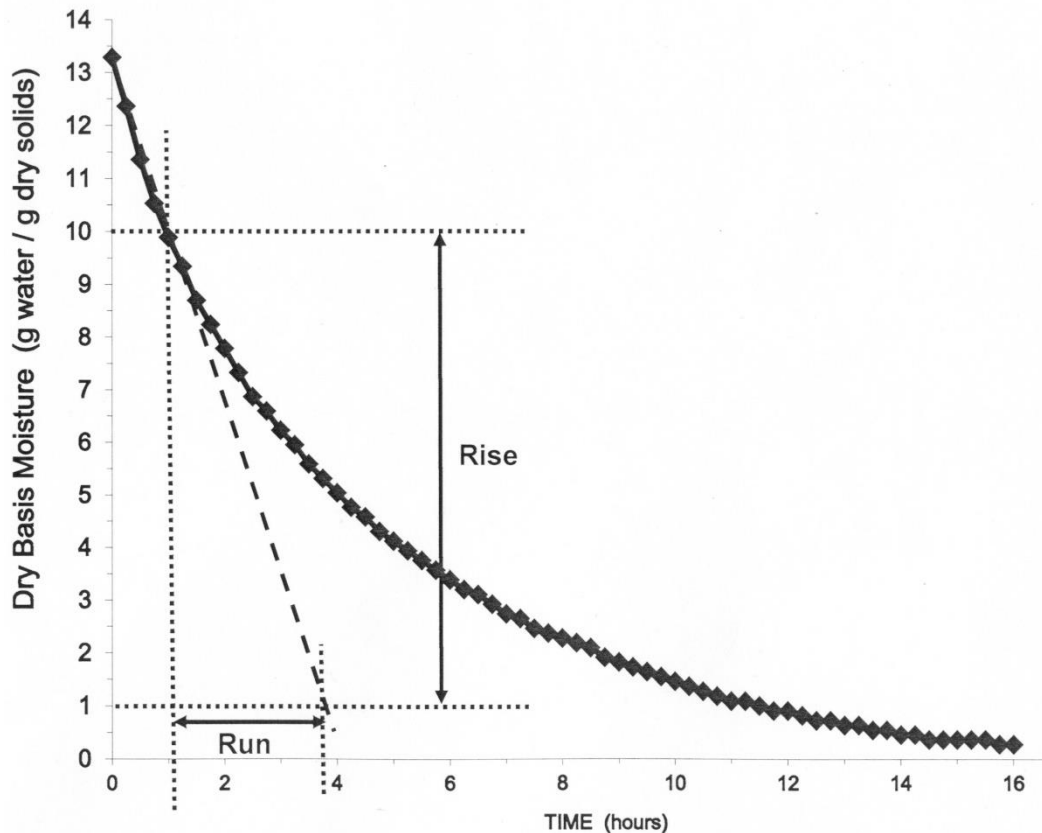

Figure 8-6: Calculation of water removal rate during the constant drying rate period

$$\text{For a straight line: } \text{Slope} = \frac{\text{rise}}{\text{run}} = \frac{\text{change in vertical direction}}{\text{change in horizontal direction}}$$

The finer dashed lines in Figure 8-6 show how the rise and run were obtained.

Horizontal lines were drawn at dry basis moistures of 1.0 and 10.0 grams of water per gram of dry solids. This gave a rise of 9.0 grams of water per gram of dry solids.

The horizontal line from 10.0 grams of water per gram of dry solids intersects the straight dashed line which we drew earlier at very close to a time of 1.0 hour. A more accurate estimate might be 1.1 hours. The horizontal line from 1.0 gram of water per gram of dry solids intersects the dashed line at a time we could estimate as being about 3.8 hours. The difference between these two times will give us a run of 2.7 hours.

$$\begin{aligned} \text{Slope} &= \frac{\text{rise}}{\text{run}} = \frac{9.0 \text{ g water / g dry solids}}{2.7 \text{ hours}} \\ &= 3.33 \text{ g water / g dry solids / hour} \end{aligned}$$

Therefore, during the “constant rate drying period”, water is being removed or lost at a rate of 3.33 grams of water per gram of dry solids per hour.

Technically, the rise in Figure 8-6 is a negative value, since the slope is decreasing. However, we can treat its magnitude as a positive value as long as we indicate that there is a loss in moisture during this period.

Once the pool of moisture on the saturated surface of the pepper slices has been evaporated and there is no longer sufficient movement of moisture from within the pepper slices to keep it replenished, the “falling rate drying period” begins. This is where drying is controlled by diffusion of moisture from within the pepper slices to the surface, where it is then evaporated.

Figure 8-7 shows how to calculate the rate of water removal at a given time within this period. First, you need to draw a tangent to the curve at the time for which you want to calculate the rate of moisture loss. This is shown by the heavy dashed line in Figure 8-7. You should then select points on either end of this tangent and use these to find the rise and run of the tangent. The finer dashed lines will assist in doing this. Based on the tangent to the curve at 6.0 hours, the rise is approximately 4.5 grams of water per gram of dry solids (i.e., 5.0 – 0.5 grams of water per gram of dry solids). The run is about 7.2 hours (i.e., approximately 10.3 hours – 3.1 hours).

$$\begin{aligned} \text{Slope} &= \frac{\text{rise}}{\text{run}} = \frac{4.5 \text{ g water / g dry solids}}{7.2 \text{ hours}} \\ &= 0.63 \text{ g water / g dry solids / hour} \end{aligned}$$

Therefore, at 6.0 hours (which is during the “falling rate drying period”), water is being removed or lost at a rate of 0.63 grams of water per gram of dry solids per hour. At times later than 6 hours, the rate of water removal is becoming slower as can be seen by how the slope of the curve is becoming less steep as time progresses.

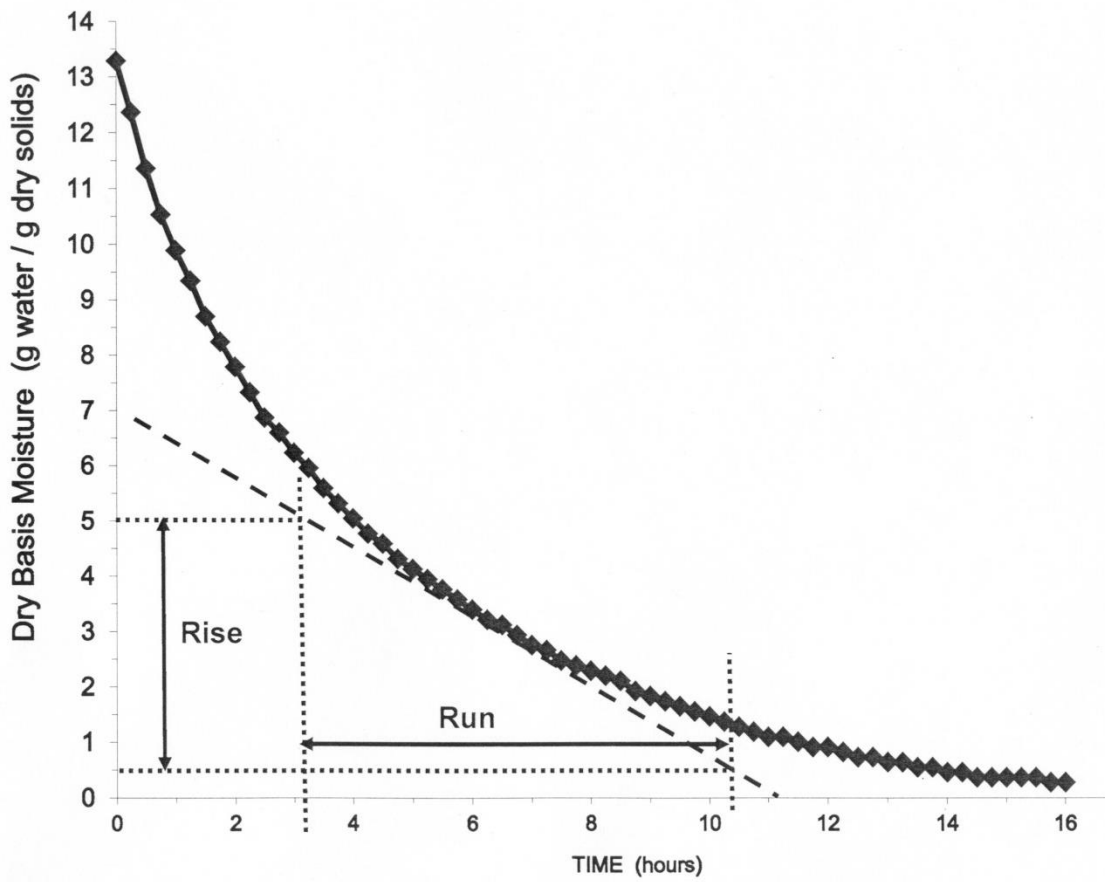

Figure 8-7: Calculation of water removal rate during the falling drying rate period

9. DRYER DESIGN AND OPERATION

9.1 Introduction:

It is not really possible, nor feasible, to present an exhaustive overview of the complexities of dryer design and operation in a single chapter. That being said, it is essential to convey the message that there are numerous configurations of dryers designed to meet a host of specific needs for a wide variety of products.

There is no single dryer design that can be applied to all drying applications.

Drying is an incredibly diverse activity covering a wide variety of applications and products. As a result, there are many different types of dryers available for food processing and other applications. In addition, there are several new concepts being developed that address highly specific needs for specialized drying applications. The purpose of this chapter is to introduce a number of these dryers to you and give a brief overview of how they operate as well as their areas of application.

We will begin by looking at various methods of applying heat to food materials, and sources of heat commonly used. Then, we will look at batch and continuous methods of drying. Following this, we will discuss airflow in dryers, before we begin to look at individual types of dryers. While we are examining the types of dryers, please keep in mind that developments are always happening in the areas of design and operation. For this reason, you should consult other sources, such as the Internet and dryer suppliers, for any details that you may require that are specific to your applications.

In most cases, I have tried to provide schematic diagrams of each type of dryer to show the basic concepts involved in their operation. Once you become familiar with the basic operating principles of the various types of dryers, you may then feel more comfortable working with dryers in an industrial setting.

**Chapter 9:
An Introduction to the Dehydration and
Drying of Fruits and Vegetables**

**Donald G. Mercer, Ph.D., P.Eng., FIAFoST
Department of Food Science
University of Guelph
Ontario, Canada
ISBN 978-0-88955-621-8
© 2014**

9.2 Direct and Indirect Heating:

A key feature that separates one classification of dryers from another is the method by which heat is delivered to the product being dried.

The most common method of delivering heat to materials in a dryer is referred to as “direct” heating. Here, the drying medium is air which has been heated prior to entering the drying chamber. It may be heated by passing it through the flames of a burner (such as a natural gas burner, etc.), or by passing it across heated metal surfaces where it picks up heat that it then carries and transfers to the material being dried. The diagram

on the left in Figure 9-1 shows how this can be done.

There may be cases where it is not suitable to dry materials with the direct application of heat from hot air. In these instances, the product may be brought into contact with heated surfaces and the heat can then be transferred to the material in this manner. Hot surfaces such as those on the outside of rotating metal “drums” with steam circulating through them are one method of indirect heating that may be used. This is shown in the diagram on the right in Figure 9-1.

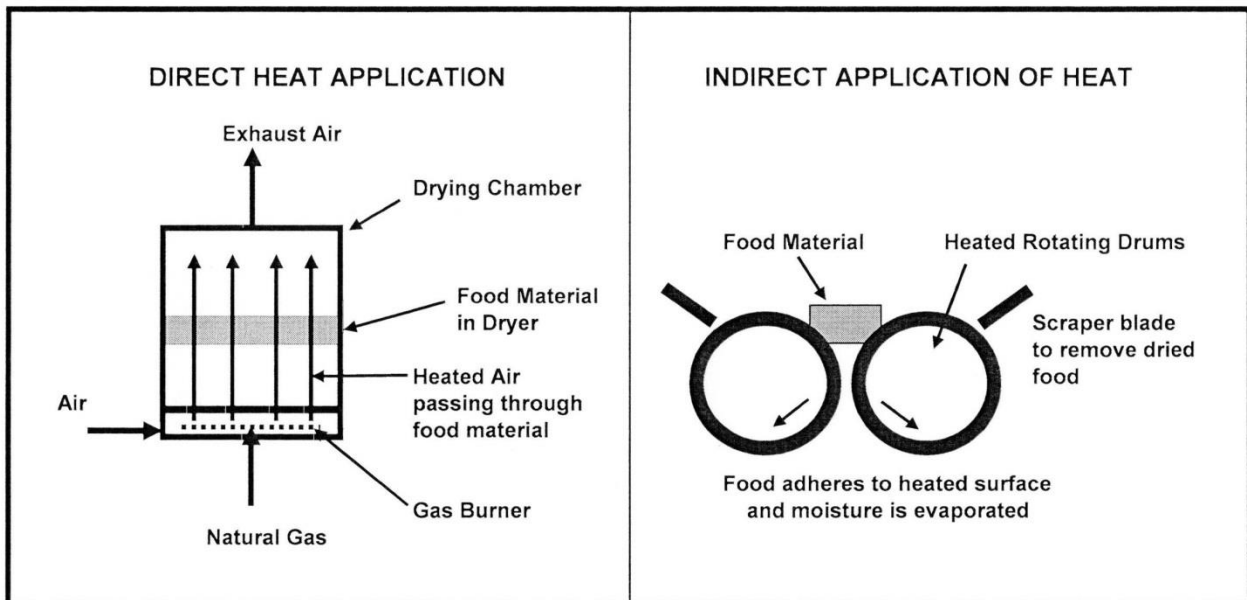

Figure 9-1: Direct and indirect application of heat

9.3 Batch and Continuous Dryers:

Another way in which we can classify dryers is through the manner in which they are used.

Consider the example of when we dry small quantities of materials in the laboratory (or even in our kitchen). We often put the material inside a bench-top dryer (or our kitchen oven); we start the dryer to remove moisture; and finally, we take the dried material out of the dryer once the desired final moisture has been reached. This process is referred to as “batch drying”. The dryers are called “batch dryers” since we have dried the material in small batches.

Small food dehydrators that function as batch dryers are available commercially. They allow the user to place several kilograms of material on trays inside the dehydrator and remove the moisture by blowing hot air through the unit.

Figure 9-2 shows a cabinet dryer which is a type of batch drying apparatus. An explanation of the various features is included in point form below the diagram.

If you take a close look at the commercial food dehydrators available for in-home use, you will see that they are designed in a similar manner to a cabinet dryer. The only major difference is that many of the features are built-in and hidden from view by the dryer housing.

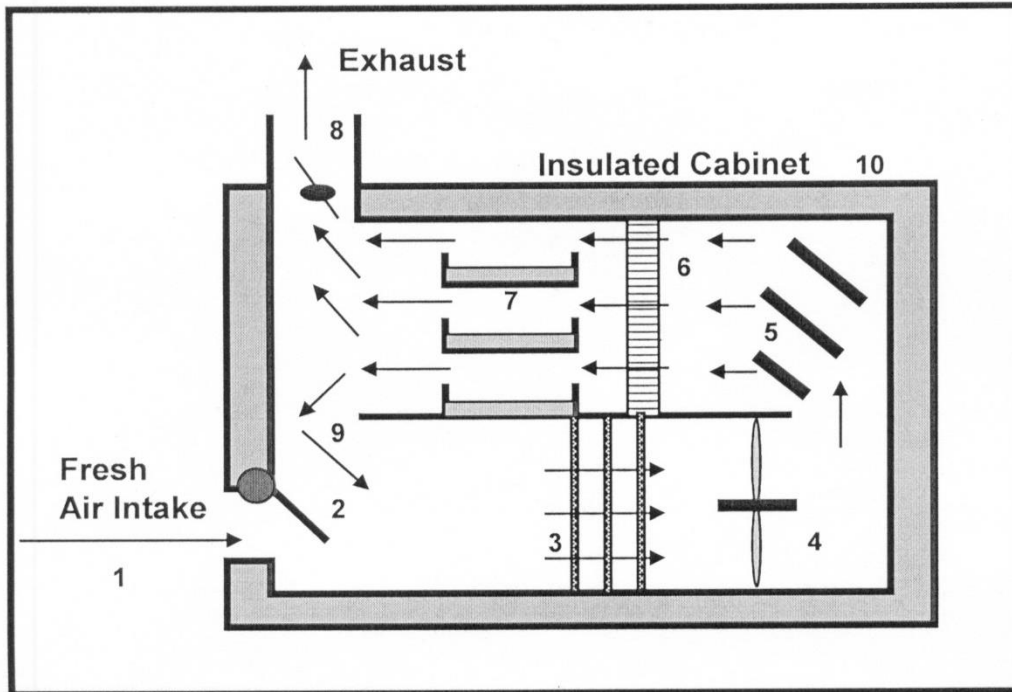

1. Fresh air enters cabinet dryer
2. Adjustable damper allows fresh air and recirculated air to be balanced
3. Heaters warm the air stream to the desired temperature
4. Adjustable fan conveys air and controls volumetric air flowrate
5. Air distribution plates "even out" flow pattern of air
6. Screens "filter" particulates from air and create back-pressure
7. Product is contained in trays with heated air passing over them
8. Air is exhausted from cabinet dryer after removing moisture from product
9. Heated air with some drying capacity may be recirculated
10. Cabinet is insulated to prevent excessive heat loss.

Arrows in schematic diagram indicate air flow

Figure 9-2: Diagram of a cabinet dryer with explanatory notes

For larger, commercial scale drying applications, it is not really practical or efficient to use a batch dryer. You cannot keep putting in small amounts of material and removing them after they are dry. This is much too labour-intensive; far too slow; and just not

practical. In cases where you may have many kilograms of material to dry and you will be working at it for long periods of time, "continuous dryers" are best suited for the task.

Consider a farmer who has large quantities of grain to dry. The drying could be done by spreading the grain in a thin layer on a wire mesh conveyor belt and passing it through a drying chamber where hot air removes the excess moisture from the grain. After travelling through the drying chamber, the grain falls off the end of the

conveyor belt and is collected in storage bins or is sent to storage silos for later use. Many industries use continuous dryers in their processes due to their convenience, reliability, and water removing capabilities.

Figure 9-3 shows a diagram of a basic continuous belt dryer.

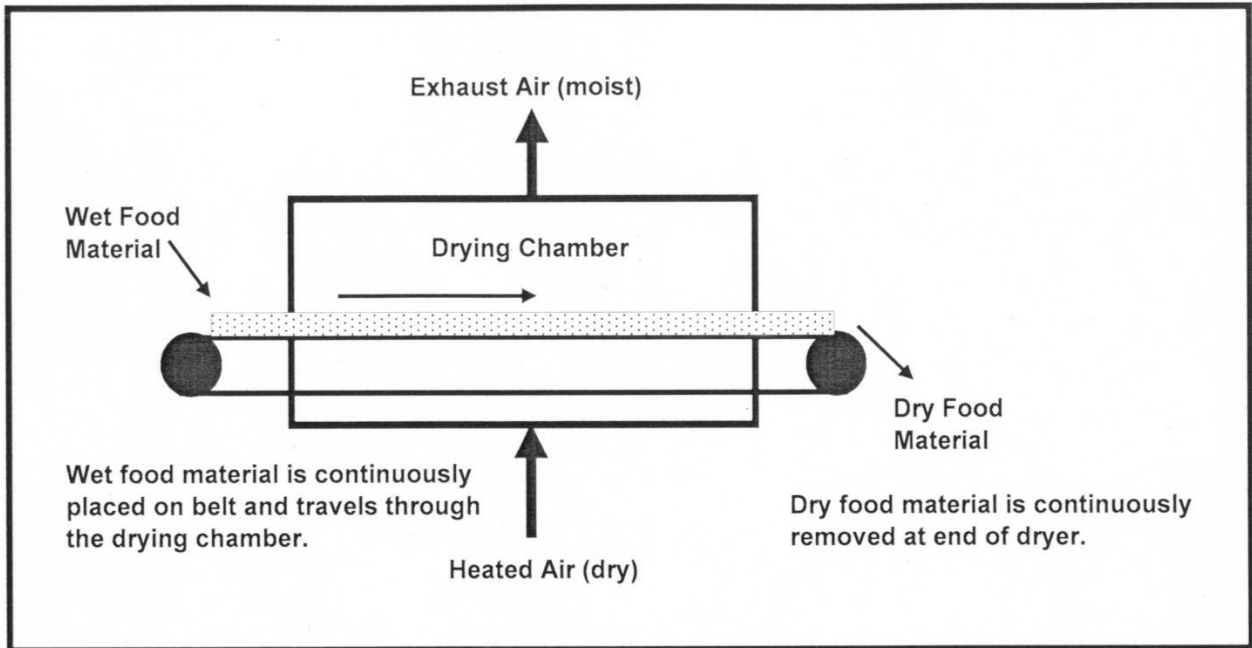

Figure 9-3: Schematic diagram of a continuous belt dryer

9.4 Airflow in Dryers:

Air is probably the most commonly used drying medium in the food processing industry.

Before we begin to examine the different types of dryers available for various applications, it would be a good idea to look at the ways in which air can be introduced into the dryers.

If you look at the continuous belt dryer shown in Figure 9-3, you can see that the heated air is being introduced into the bottom of the dryer and travels upwards through the bed of material being dried. This is referred to as “updraft”. The air then exits through ducts at the top of the dryer. The exhaust air is cooler and contains more moisture than the air entering the dryer because it has given up some of its heat to evaporate the moisture from the material in the dryer. Having air flowing upwards through the bed of material is a good way of avoiding problems encountered with soft wet products. If the air was flowing downwards through the material, it could literally push the soft material into the wire mesh of the conveyor belt where it would dry and harden. In a very short time, the belt would become plugged and no air could flow through it to dry the product.

With air travelling in the upward direction, the wet material is dried on the bottom of the bed which may harden it slightly and prevent it from being mashed into the wire mesh of the conveyor belt.

Once the bottom portion of the material has been dried somewhat, the flow of air can be directed downwards to dry the top portion of the product bed. This

“downdraft” can be accomplished by having the conveyor belt pass through various “zones” in a dryer. The zones are separated by walls or partitions in the dryer. More information regarding dryer zones will be presented later in the chapter.

In cases where very light fluffy products are being dried, it might not be desirable to have air flowing in the upward direction since this may blow the product around inside the dryer. Care must be taken to match the direction of air flow to the material being dried.

There may also be cases when it is not desirable to have updraft or downdraft flow of air in a dryer. You may want to have the air flowing along or across the surface of the material in the dryer. There are several different options available that may be used. We will look at each one of these options in turn.

Counter-current air flow is the term used to describe the situation where product is introduced into one end of the dryer and heated air is introduced into the opposite end, as shown in Figure 9-4 on the next page. In Figure 9-4, the wet material is entering the dryer from the left and leaves the dryer at the right-hand side of the diagram. Heated air is blown into the dryer from the right and leaves the dryer on the left side of the diagram. This is a very good way to maximize the efficiency of the drying operation.

The air entering the dryer in Figure 9-4 is at its highest temperature just as it enters the dryer. It also has its lowest water content at this point. The combination of being at its highest temperature and lowest water content

means that the air has its highest capacity to remove water.

This is also the point where it is most difficult to remove moisture from the product which is almost finished being dried, but is in its falling rate drying period where diffusion is slow .

As the air travels to the left of the dryer in Figure 9-4, it continues to lose heat as it evaporates moisture. As it is leaving the dryer at the left-hand side of the diagram, it still has sufficient heat to warm the incoming cool wet material. At this point, the air has its lowest water removal capacity, but since it is in contact with very wet product, it may still be able to pick up some moisture before it leaves the dryer.

In all these arrangements, the hot dry air is directed to contact the product travelling through the dryer.

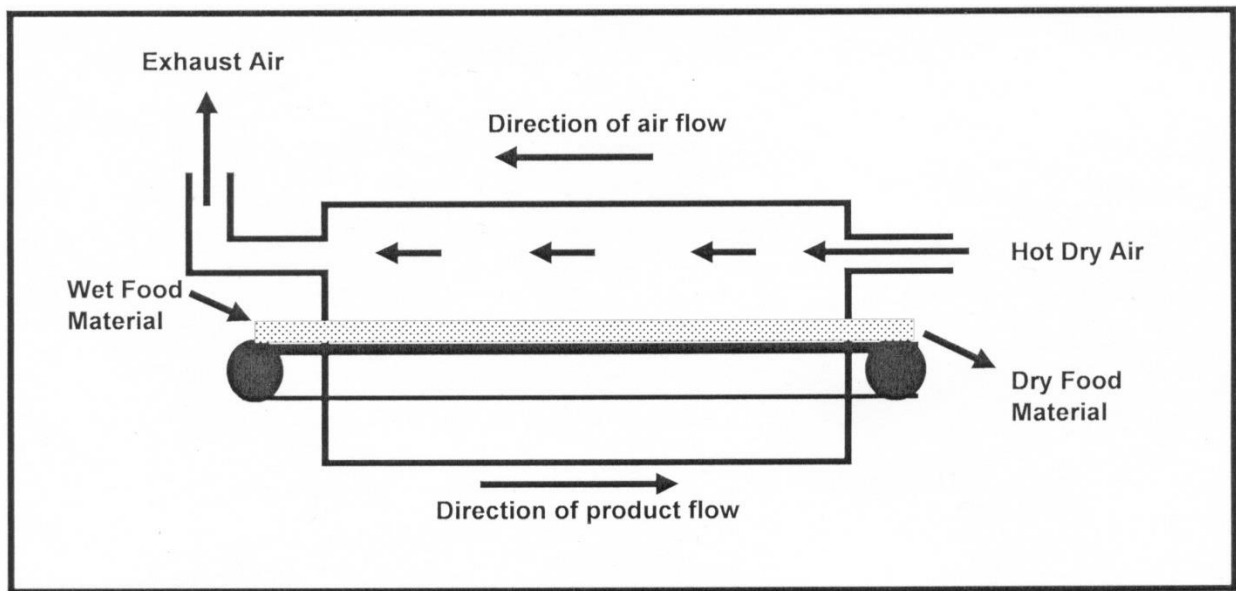

Figure 9-4: Counter-current air flow in a continuous belt dryer

While counter-current air flow maximizes the driving forces of temperature and moisture difference between the air and the material being dried, it may pose a problem in some applications. For this reason, we should consider co-current air flow.

Co-current air flow describes the situation where the heated air for drying and the material to be dried are both introduced into the dryer and flow through the dryer in the same direction. Looking at Figure 9-5, we can see how this takes place.

With co-current airflow, we are bringing the hottest, driest air into contact with the wettest, coolest material. This avoids the danger of over-heating the product before it leaves the dryer, which can happen with counter-current airflow. Excessive heat may damage delicate products and it should be avoided if there is a danger of doing harm to the product quality by exposing it to excessive heat. While there are not the most optimum differences in temperature and moisture content helping to dry the product, the effects may be more gentle on the product itself.

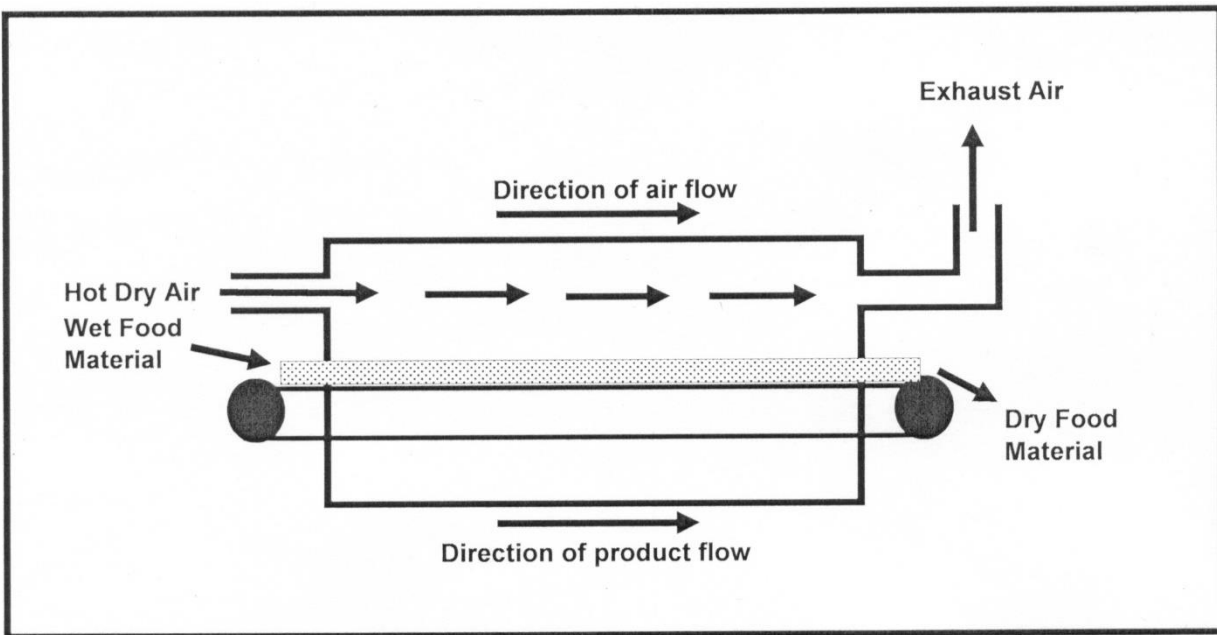

Figure 9-5: Co-current air flow in a continuous belt dryer

Some drying applications may use a combination of counter-current air flow and co-current air flow by having them in two separate sections of the dryer as shown in Figure 9-6.

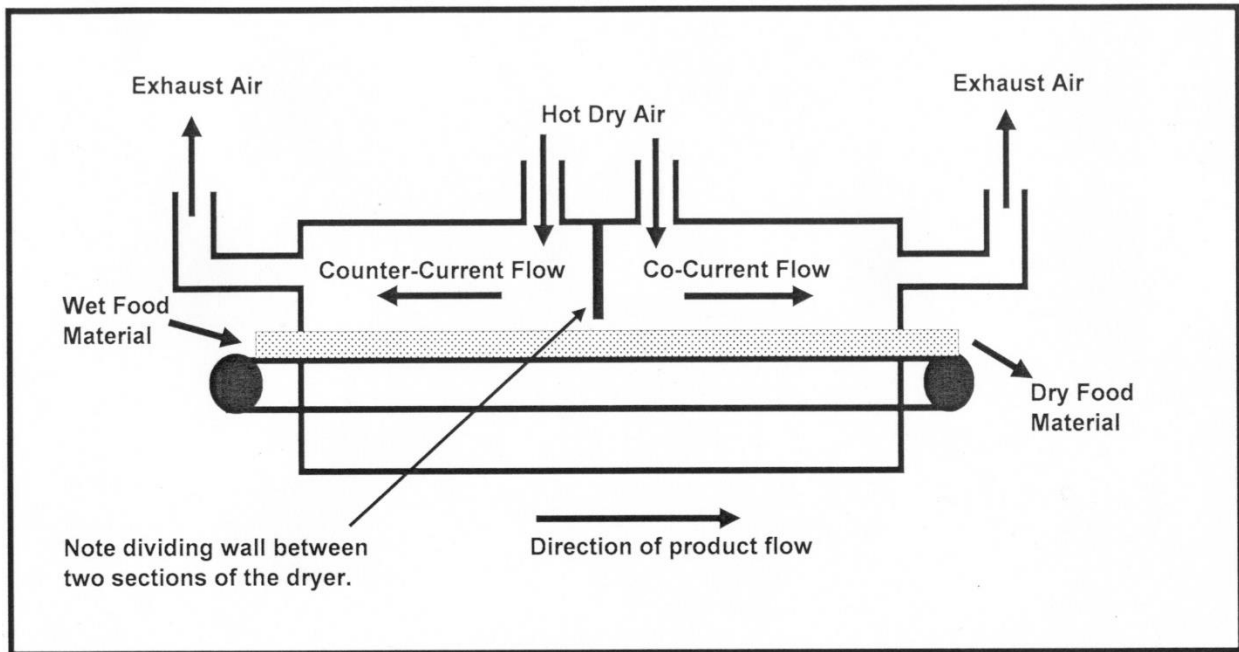

Figure 9-6: Combined co-current and counter-current air flow in a continuous belt dryer

Another option for the direction of air flow is across the surface of the material being dried from one side of the dryer to the other. This would be referred to as “cross-current air flow” and is shown in Figure 9-7.

One potential danger here is having material on one side of the drying bed becoming dryer than material on the other side of the bed. This would be similar to the flow of air in a batch dryer where the bed of material is not moving. The air is simply blown across the bed of material from one side of the dryer to the other.

Special Note:

Whatever direction we have for the airflow in a dryer, having a uniform distribution of the air is absolutely essential in order to get a uniformly dried final product. We will come back to this topic when we discuss continuous belt dryers.

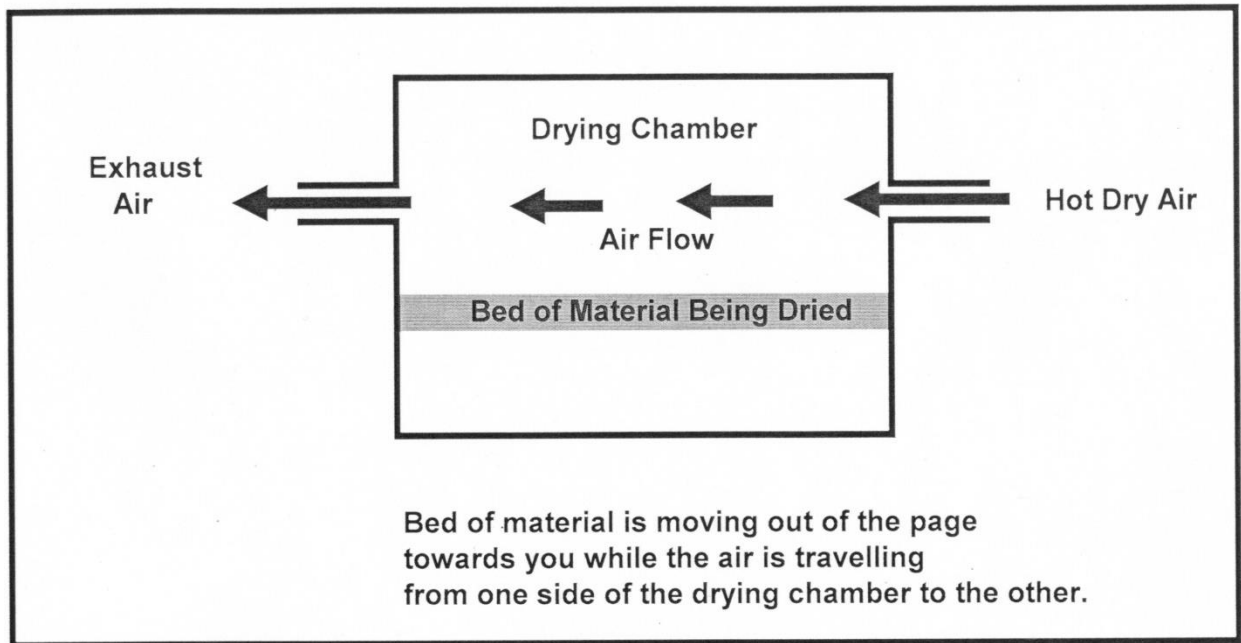

Figure 9-7: Cross-current air flow in a continuous belt dryer

9.5 Types of Dryers:

Now that we have had a look at how we get the heat to the product in dryers using hot air, we should examine several of the different types of dryers that are available to the food processor. These dryers may be divided into two main groups: “traditional” dryers and “emerging technology” dryers. Even though we may only be able to take a quick look at just a few different types of dryers, there are many variations of dryer types that have been designed to meet special needs in food drying. You should consult a drying specialist for a dryer to meet your specific drying needs. We will consider the “traditional dryers first.

Traditional Dryers:

9.5.1 Continuous Through-Circulation Dryers:

This type of dryer is often called by names such as a “continuous belt dryer” or “conveyor belt dryer” etc. It is similar to the dryers shown in Figures 9-3 through 9-6. Basically, the material to be dried is spread evenly on a wire mesh belt which travels through the drying chamber. The time that the material spends in the dryer is controlled by the speed of the belt. The amount of heat delivered to the dryer is determined by the temperature of the heated air, and the volume of air blown into the dryer in a given period of time.

Figure 9-8 shows a side view of a continuous through-circulation dryer with four zones for drying the product. Zones 1 and 3 have updraft and zones 2

and 4 are downdraft zones. These are other air flow options available in addition to counter-current, co-current, and cross-current directions.

In some belt dryers, the final zone may be used for cooling the product before it leaves the dryer as is the case in Figure 9-8. Cooling helps to “set up” the product. If the product happens to be starchy in nature, cooling it will make the starch become more solid rather than being soft and pliable. This can be very important if the starchy product is going to be held in a bulk storage bin prior to being packaged.

Hot or warm products may “sweat” during storage and give off moisture which collects on surfaces of the storage bin. Later this moisture may cause mold growth to occur. Hot products also tend to be somewhat soft, which can cause them to alter their shape or change their structure as they cool.

Each zone in the continuous through circulation dryer can have its air flow and air temperature controlled independently from the other zones. Care must be taken in each drying zone to match the application of heat to the drying needs of the product.

In zone 1, the material may be in its constant rate drying period, so moisture is being evaporated from the surface. This means that it may be possible to use high air temperatures without damaging the product. The updraft direction of air flow prevents the air from pushing the moist material into the mesh belt.

As already stated, having material pushed into the belt can cause the wire mesh to become plugged and not allow air to pass through it during the drying process.

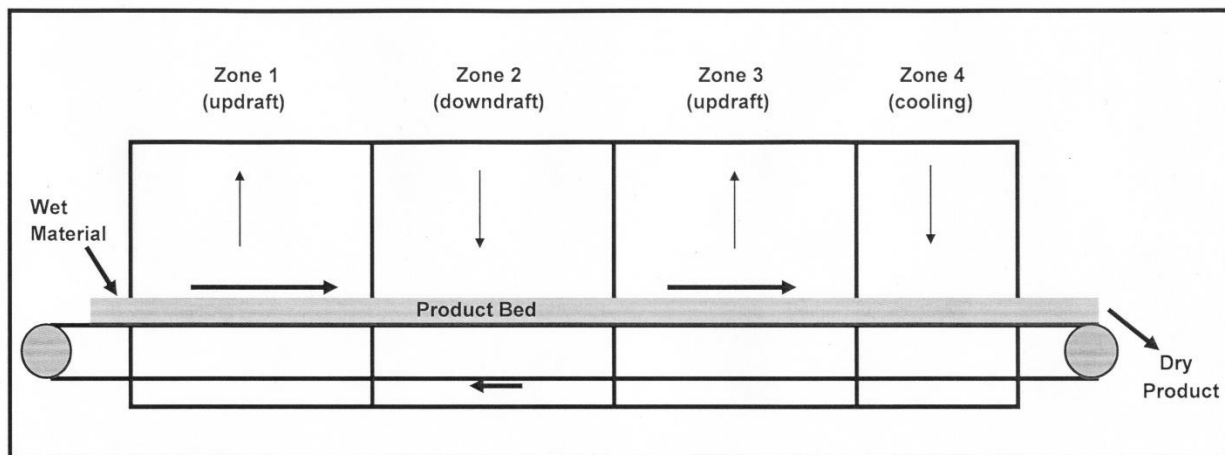

Figure 9-8: Continuous belt dryer with four zones

In zone 2, a lower temperature might be used since the material may be in its falling rate drying period where moisture must diffuse to the surface before it can be removed by the drying air. If high air temperatures were used, the material could heat up and become damaged by the heat. Even if the product was still undergoing constant rate drying, it may be a good idea to change the direction of the airflow so that the top of the drying bed becomes dry and the bottom does not become overly dry.

Zone 3 is a second updraft zone. It would generally have a much lower air flow than zone 1 because the product is lighter than it was when it contained a lot of water as it did in zone 1. If high air flows were used, the speed of the air could be sufficient to lift pieces of material off the drying belt and blow them around inside the dryer. This would create uneven drying and could also result in product being blown out of the dryer.

Continuous through-circulation dryers can have any number of zones. The actual number depends on the nature of the product being dried and other such considerations including air temperatures during drying and the air flow rates.

These dryers are used in many drying applications where the particles of material are easily handled and can be spread on a belt for drying. They may be used for drying grain and cereal products, animal feed, etc.

9.5.2 Tunnel Dryers:

Tunnel dryers are similar to continuous through-circulation dryers in many respects. The big difference is that the material is not placed on a moving conveyor belt. Instead, the material to be dried is spread on trays or racks that are then put onto carts that are pulled through long tunnels where heated air is blown across the material on the trays or racks. Figure 9-9 shows such a dryer.

The carts are manually loaded and pushed into the “front end” of the dryer. They can either be fastened to a chain that will pull them through the tunnel, or the wheels of the cart may be grabbed in an assembly that will pull them through the tunnel. The speed at which they are pulled determines the time the material spends in the dryer. Once the carts reach the end of the dryer, they are pushed out and unloaded. The empty carts are then returned to the start of the dryer to be reloaded and sent through the dryer with a fresh load of wet product.

These dryers require much more labour to operate than a continuous belt dryer and are not as commonly used as they once were.

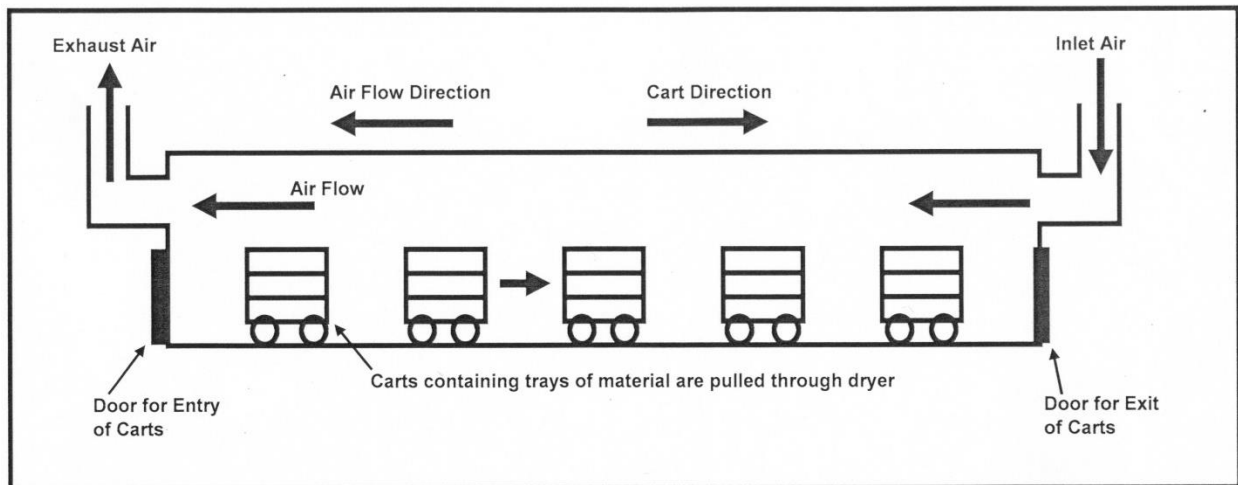

Figure 9-9: Diagram of a tunnel dryer with movable carts

9.5.3 Cabinet Dryers:

Cabinet dryers represent a basic type of batch style dryer. We have already seen a cabinet dryer in Figure 9-2. It is reproduced here as Figure 9-10 without the explanatory notes for the sake of completeness.

The material to be dried is placed on racks inside the drying chamber of the

cabinet and hot dry air is blown across it.

An understanding of the operation of a cabinet dryer will be of assistance in our discussion of tray dryers, since there is essentially little or no difference between the two.

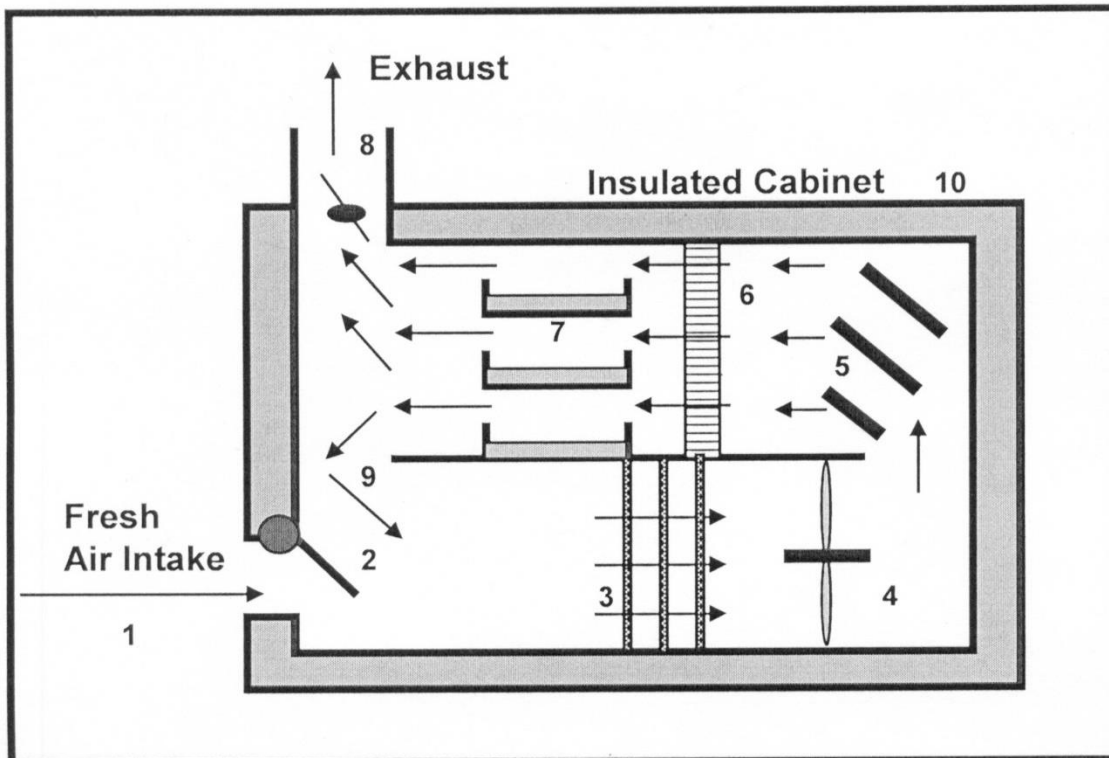

Figure 9-10: Diagram of cabinet dryer (see Figure 9-2 for details)

9.5.4 Tray Dryers:

Tray dryers are another type of batch dryer that is often used in small-scale food drying operations. In many respects, they resemble cabinet dryers.

In a tray dryer, the material to be dried is placed on large trays, generally made of metal. The tray itself can be a solid sheet of metal, or it may have a more open structure with slots or holes in it to allow drying air to pass through the material being dried. Wire mesh is often used as it maximizes the amount of open area for air circulation.

Once they are loaded, the trays are placed on supports inside a drying cabinet or compartment. The trays look like shelves inside a large box that is actually the dryer.

After all the trays have been loaded, the drying chamber is closed and air is blown through the drying compartment.

By monitoring the humidity of the air leaving the tray dryer, the progress of the drying process can be followed. Once the drying is completed, the air flow is stopped; the dryer is opened; and the trays are removed. The dried contents of the trays are then dumped and the trays are reloaded for the next load of product that is to go into the dryer.

Figure 9-11 shows a diagram of a tray dryer.

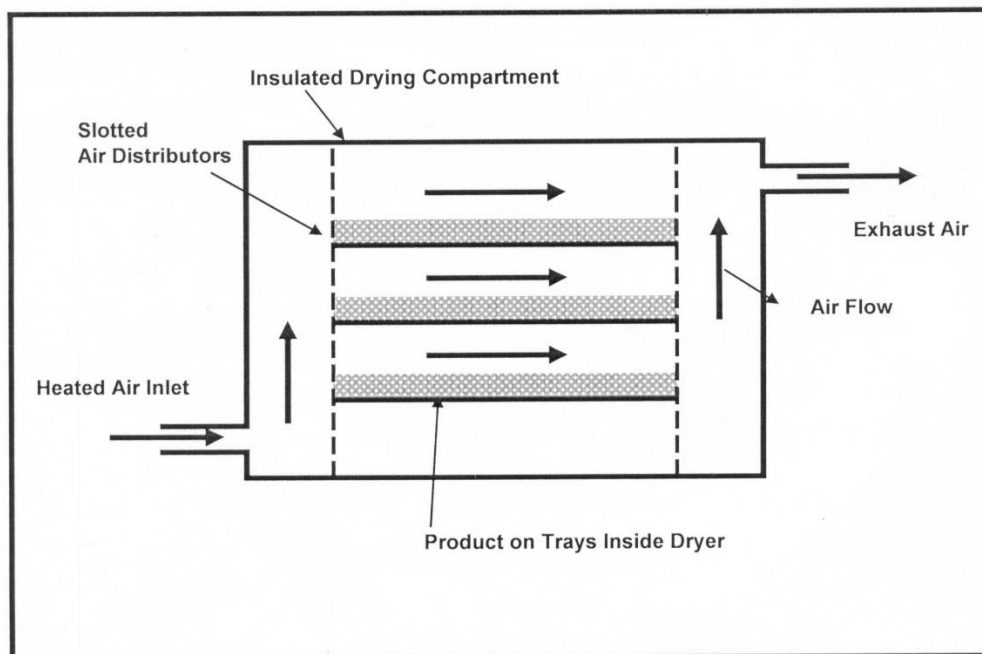

Figure 9-11: Diagram of a tray dryer

9.5.5 Fluidized Bed Dryers:

Fluidized bed dryers recognize the fact that drying can be done much more efficiently if all surfaces of the product being dried are in contact with the drying medium, which is usually heated air. Such dryers can be either batch or continuous in their design and operation. For our example purposes, we will examine a batch fluidized bed dryer.

Consider a chamber with small openings in its bottom and top. The openings are large enough to permit air to pass through them but do not allow particles of material being dried to escape.

Figure 9-12 is a schematic representation of such a dryer.

Heated air is blown into the drying chamber through the openings in the bottom. By using a sufficient volumetric flowrate of air, a linear velocity can be achieved that is sufficient to lift the wet product pieces and keep them suspended in the air that is drying them. While in their fluidized state, it appears as if the particles are “dancing” in the air that is drying them. As the process continues, the product particles lose moisture and become less dense. This means that the air flowrate must be reduced so as not to lift the particles too much and pack them against the openings in the top of the drying chamber. When drying is completed, the batch of product can be removed from the drying chamber and a fresh batch of wet product can be inserted for drying.

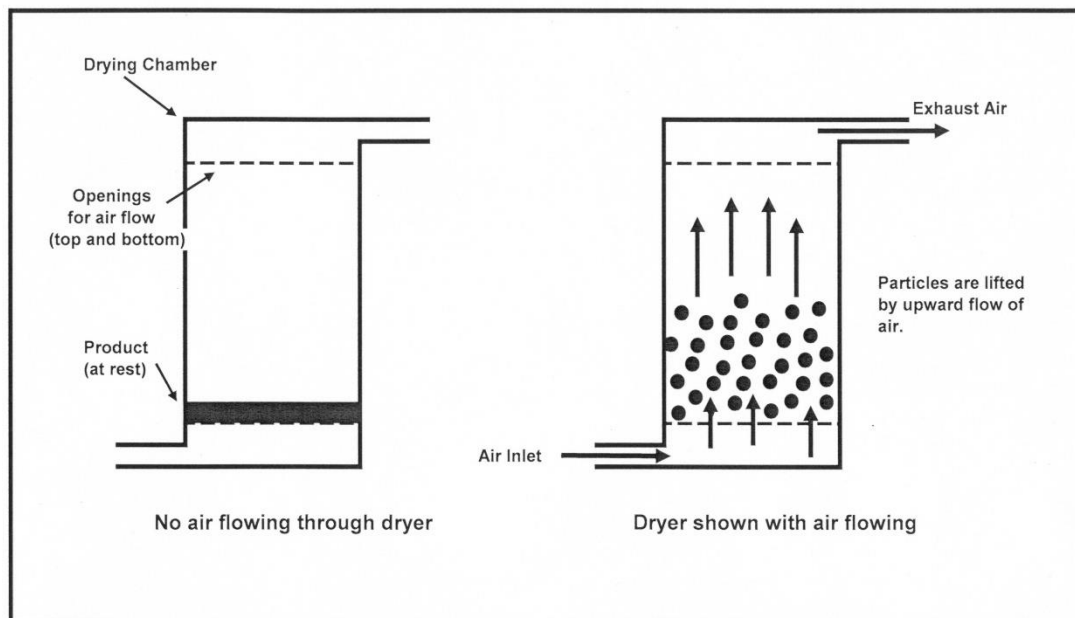

Figure 9-12: Diagram of a fluidized bed dryer (without air low on the left)

9.5.6 Vibrating Bed Dryers:

Vibrating bed dryers also recognize that it is important to expose as much of the surface of a product to the drying medium. When dealing with starchy products that can have a sticky surface, these dryers may be used in series with another dryer, such as a conveyor belt dryer. In the conveyor belt dryer, the surface of the product is dried to the point where the product is no longer sticky. Essentially, this will be at the end of the constant drying rate period. If the material is left on the conveyor dryer, the points where each particle touches another particle will experience slower drying than fully exposed surface areas.

The bed of partially dried material leaving the conveyor belt dryer can be broken up and fed into a second dryer which has a vibrating surface onto which the product particles are spread. Air is introduced through small openings in the vibrating bed, or is blown into the dryer from above or from the sides. As the particles are thrown a short distance upwards, they are in full contact with the heated air. As soon as they come back down onto the dryer bed, they are once again thrown upwards into the drying air. This procedure is repeated many times as the particles travel from the feed end of the dryer to the discharge end where they go on to further processing, storage, or packaging, etc.

Refer to Figure 9-13 for a diagram of a vibrating bed dryer.

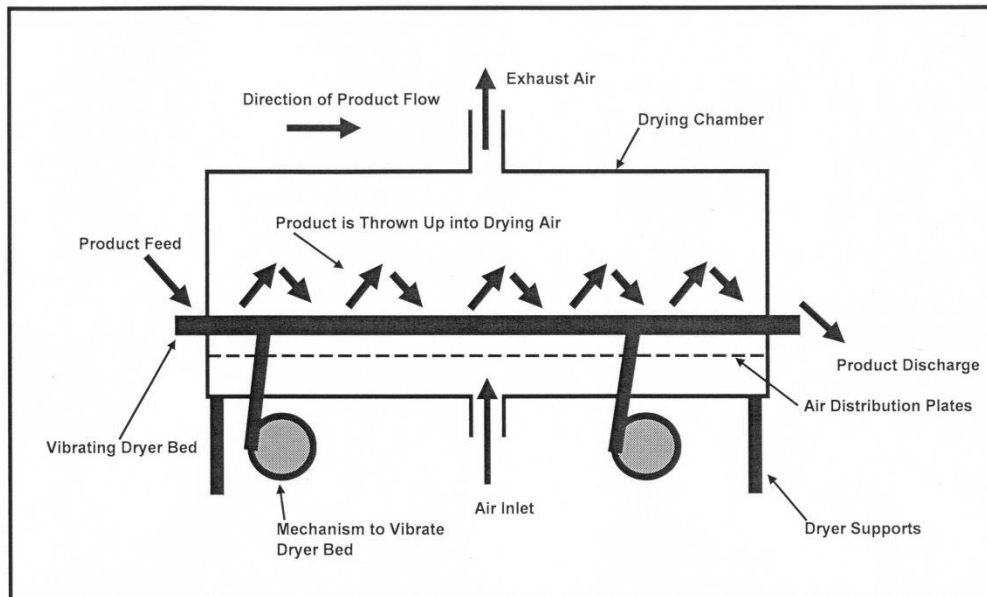

Figure 9-13: Diagram of a vibrating bed dryer

9.5.7 Spray Dryers:

Spray dryers are typically used in cases where solids are required to be separated by drying liquid streams. An example of this would be in the recovery of whey solids from liquid whey in a cheese-making operation. See Figure 9-14 for a diagram of a spray dryer. There are many different designs and configurations. However, their basic operation is quite similar.

In spray drying, the liquid is pumped through an atomizing nozzle that creates small droplets that are then distributed uniformly into a large drying chamber, or tower, where they are allowed to fall

through heated air that is circulating in an upwards direction. As the droplets fall through the heated air, they lose moisture. By adjusting conditions such as droplet size, air temperature, and air velocity, etc., the desired degree of drying can be achieved so that by the time they reach the bottom of the dryer, the droplets have become small particles of powder. This powder can be collected at the bottom of the spray drying tower. Any powder being carried out of the spray dryer in the exhaust air can be recovered through the use of one or several cyclone separators.

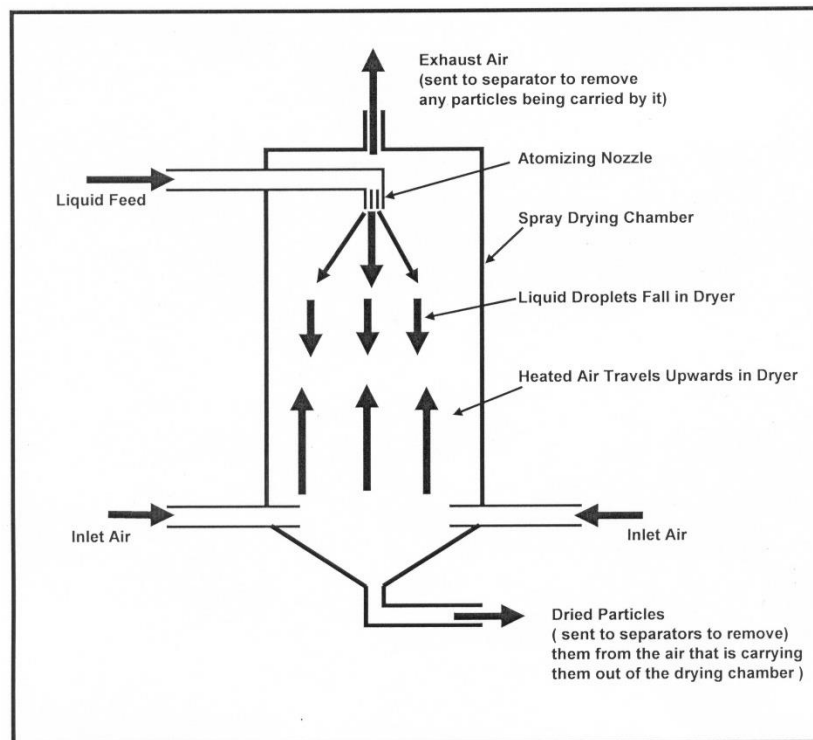

Figure 9-14: Diagram of a spray dryer

9.5.8 Drum Dryers:

Drum dryers use heat from steam or hot water to warm a set of metal drums to the desired temperature. The drums rotate in opposite directions (as shown in Figure 9-15). The material to be dried is introduced into the narrow gap, or “nip” between the drums. This material can be a viscous liquid or a “mushy” solid. An example of a solid being dried on a drum dryer would be the conversion of mashed potatoes into dried flakes for use as instant mashed potatoes. After it goes through the “nip”, the material sticks to the surface of the rotating heated drum and moisture evaporates from it. Just before it travels back to the top of the dryer, the dried material is removed from the drum using a “doctor blade” that continuously scrapes the drum surface. As it falls, the dried product is caught in a hopper and is removed for further processing.

There are numerous variations in the operation of drum dryers. Each method is designed to suit a particular drying need or product characteristic. Some dryers have only one of the drums heated instead of both of them, and others have different ways of getting the wet material onto the drum for drying.

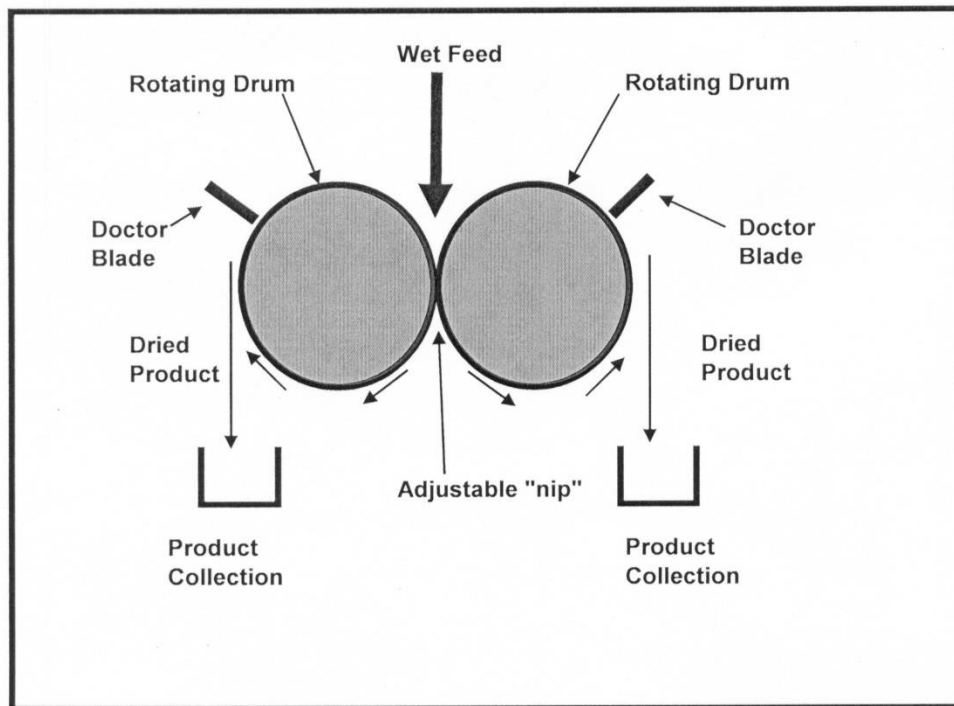

Figure 9-15: Diagram of a drum dryer

9.5.9 Other Types of Traditional Dryers:

In the previous sections of this chapter, we have looked at several traditional dryer types that have been the workhorses of the food drying industry for many years.

In addition to those dryers described above, there are other dryers which have been developed to meet new drying demands.

The following types of dryers are also available for consideration in food processing applications.

- Freeze dryers
- Flash dryers
- Plate dryers
- Rotary dryers
- Vacuum dryers
- Solar dryers
- Roto-louvre dryers
- etc.

Should you wish to study any of these additional types of dryers, you may find the Internet to be of particular assistance.

Before deciding upon a specific dryer for a processing task, care should be taken to investigate all suitable types of dryers and to pick the one most appropriate for the product. You should work with a dryer specialist or drying company and recognize the needs to match the dryer to the product being dried. The purchase of a dryer is often a major capital expense. Mistakes made in the selection of a dryer cannot be easily corrected in most cases.

9.6 Emerging Technologies:

In a chapter of the book "Food Science and Food Biotechnology" (edited by G.F. Gutierrez-Lopez and G.V. Barbosa-Canovas; Food Preservation Technology Series, by CRC Press, 2003), Dr. Arun Mujumdar, discusses a number of additional developments in the field of drying technology.

He lists the following new dryer designs:

- Heat pump dryers
- Intermittent batch dryers
- Vacuum fluid-bed dryers
- Sorption dryers
- Pulse combustion dryers
- Cyclic pressure / vacuum dryers
- High electric field dryers
- Superheated steam at low pressure dryers

Each one of these dryers addresses a special concern in the drying of a particular product.

You may wish to investigate these further using on-line sources of information.

10. UNIFORMITY IN DRYER OPERATION

10.1 Introduction:

As stated in Chapter 9, there are many types of dryers available and each application must be assessed on an individual basis to optimize the drying process.

The continuous belt dryer used in the previous section will serve as a means of examining some of the problems encountered in drying on an industrial scale.

10.2 Creating a Uniform Product Bed:

To ensure the best possible performance for any type of dryer, it is essential to have a uniform bed of material on the dryer belt. The material being dried must then be exposed to a uniform, controlled drying environment.

Methods of establishing a uniform product bed are varied and often imaginative. They are dependent upon the nature of the material being dried, and on the nature of the discharge stream from the previous unit operation in the process sequence. Some materials may be conveyed in a water slurry and spread on the dryer belt by dams or weirs, and drained prior to entering the dryer itself. Other materials may be “airveyed” (i.e., blown in a stream of high-velocity air) and blown onto the belt through tubes that sweep from side-to-side across the dryer belt.

Chapter 10:
An Introduction to the Dehydration and Drying of Fruits and Vegetables

Donald G. Mercer, Ph.D., P.Eng., FIAFoST
Department of Food Science
University of Guelph
Ontario, Canada
ISBN 978-0-88955-621-8
© 2014

10.3 Creating Uniform Air Flow:

Delivering the drying medium (usually heated air) to the product is a major challenge. "Air distribution plates" are the most commonly used method in continuous through-circulation dryers. These plates are simply large sheet-metal panels with small holes (typically 1 to 2 cm in diameter) spaced at regular intervals to give an appropriate open area (perhaps 25%). Sufficient back pressure must be created by the air distribution plates to establish a uniform flow of air through the holes in the plate. The flow must be uniform both across the product bed, and along the total length of the dryer zone. Non-uniform air patterns will result in non-uniform drying.

Figures 10-1 and 10-2 show the positioning of air distribution plates in updraft and downdraft zones of a dryer, respectively.

In the case of airflow in an updraft zone (Figure 10-1), air enters the drying chamber below the product bed. Due to the large open volume and the high velocity of the air, the air flow patterns are very chaotic. Air from the fan may be blown across to the far side of the dryer and be deflected in a random manner from the wall of the dryer. If nothing was present to even out the air flow, there would quite probably be a highly non-uniform distribution of air going upwards through the product bed. However, with the air distribution plates in place, the chaotic flow of air is essentially trapped below the

distribution plates and cannot reach the product bed until the air flow pattern is made more uniform.

The air distribution plates create a back-pressure by allowing only a portion of the air to pass through the small holes. This creates a uniform flow at all locations beneath the product bed so that when the air does travel upwards, all product spread on the dryer belt receives the same degree of exposure to the drying air. Each hole in the air distribution plates functions as an individual "nozzle" directing air upwards towards the product

In the downdraft zones of the dryer (Figure 10-2), the same approach is used for the air distribution plates. The plates are placed between the source of the air (i.e., the fans) and the product bed to prevent chaotic air flow from reaching the product bed. As can be seen, the air distribution plates are located above the product bed in this case. The air travels down through the holes in the plates before it strikes the product bed.

In some cases a second set of distribution plates or air deflectors could be used to further ensure the uniform distribution of air in the downdraft zones. This might be necessary due to the large volume of space above the product bed in most dryers of this type.

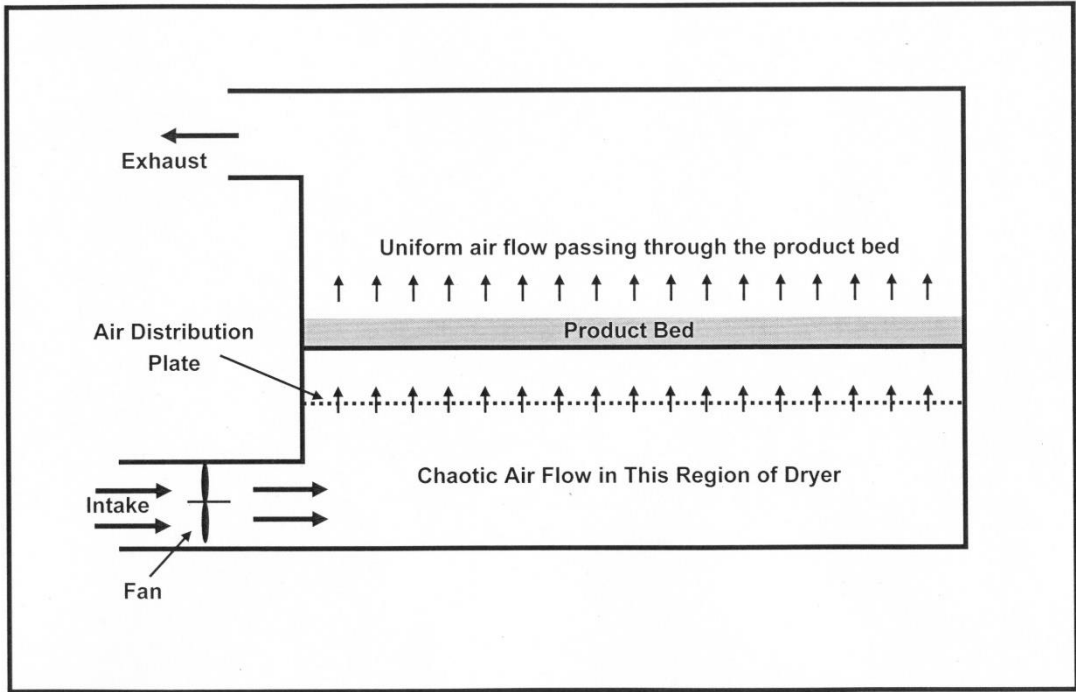

Figure 10-1: End view of air distribution plates in an updraft zone of a dryer (product is coming out of the page towards you)

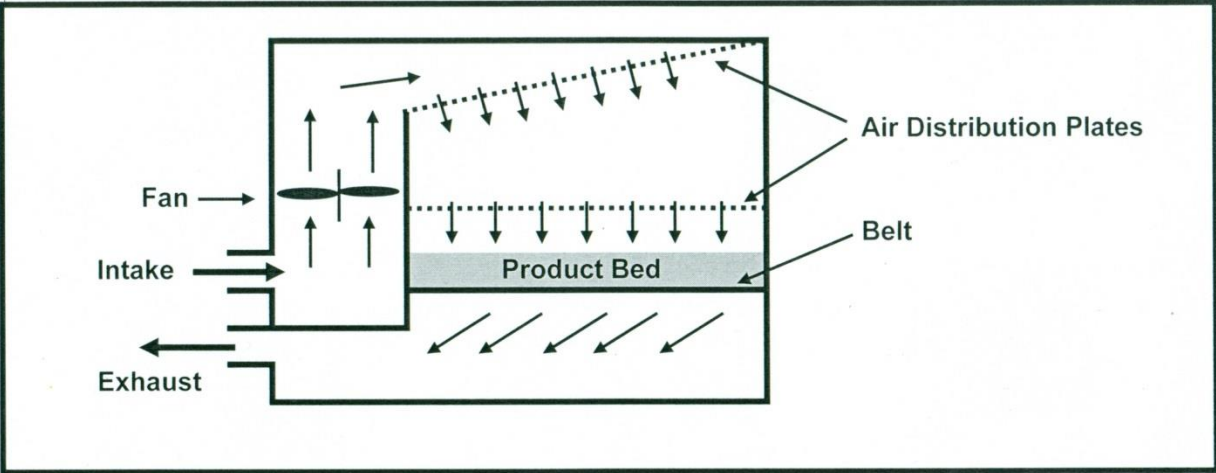

Figure 10-2: End view of air distribution plates in a downdraft zone of a dryer (product is coming out of the page towards you)

10.4 Volume of Air to the Dryer:

The volume of air being sent to the dryer may be controlled in several different ways. If the dryer is so equipped, variable-speed drives can be used to adjust the speed of the fans. The faster the fan is spinning, the more air that will be delivered to the dryer. The specifications of the manufacturer and the appropriate fan curves (i.e., curves defining the air delivery of a fan under a set of given conditions such as speed, temperature of the air, back-pressure, etc.) must be used to determine the actual delivery rates. In addition, tests to determine air velocities should be conducted to verify results. This is a topic best left for further instruction, or hands-on training.

A second way to control the amount of air delivered by a fan is through the use of louvers or dampers to control the open cross-sectional area of the plenum through which the air is flowing.

A third way to adjust the air delivered by a fan is by using volume control disks mounted on the central shaft of the fan. These disks can be moved along the shaft to control the percentage of the blades of the fan available to blow air into the dryer. This concept is somewhat more complex than the other two and is also more difficult to use since the fans must be shut off and the dryer cooled down to enable crews to go in and physically adjust the volume control disk positions.

10.5 Assessing Dryer Performance:

10.5.1 Drying Uniformity:

How well a dryer does its job is determined by a wide variety of factors. In general, however, the success of drying a product comes down to how well you as a processor understand the behaviour of your product while it is being dried, and how well you match the operation of the dryer to your product's drying needs.

The first thing that you must realize is that there is a limit to how much water can be removed from a particular type of material by a given dryer in a specified period of time.

Suppose you buy a dryer that is designed to dry grain and remove a certain amount of water from it on an hourly basis. Let's assume the dryer can remove up to 1,500 kg of water per hour from a specified input rate. You should not expect to dry more grain which requires that you remove 2,000 kg of water per hour. Some operators try to do this by turning the temperature controllers up to their maximum settings to get the air as hot as possible. They also turn the fans up to their maximum settings to deliver as much air as possible. In spite of these measures, they still fail to get an acceptable product, since they have not taken into account the time it takes for the moisture inside the kernels of grain to diffuse out to the surface and be removed. Even if the conveyor belt is slowed down to allow the grain to spend more time in the dryer, the results are usually not encouraging because the thickness of the drying bed increases and the air cannot penetrate through it and remove the desired moisture.

Consider the following factors:

- Time:
Kinetic factors such as diffusion control the removal of moisture. It is not simply matter of blasting the material with copious amounts of hot air.
- Nature of the Product:
This is critical. Not all products dry in the same way. You cannot expect to have grain dry in the same manner as flakes of parsley or other leafy plant material.
- Temperature:
Excessive temperatures can damage your product. You cannot keep increasing the heat to drive off moisture without scorching or burning your product or without decreasing its nutritional or functional properties.
- Air Flow:
The air entering a dryer must be distributed uniformly to all product in a particular drying zone. Its rate of delivery (linear and volumetric) must be such that it does not disrupt the product bed. The air must also have a relatively low moisture content to maximize its ability to remove moisture from the product in the dryer.

- Material Bed Characteristics:
The product must be distributed evenly from side-to-side and along the dryer belt. Its thickness must be sufficient to ensure that it is not disrupted by the air passing through it and it cannot be so thick as to be impenetrable to the air.
- Other Factors:
Other factors exist that are specific to each dryer that impact its operation. The operator of the dryer must identify and understand how these factors relate to the drying of his or her specific product.

All of these factors are usually taken into account by the dryer manufacturer. It is rather shocking that manufacturers are blamed for problems when the dryer is not being used in the manner in which it was designed to be run. Processors may even be running a product that the dryer was not designed to dry; and they may be using improper drying conditions.

No dryer can be expected to operate properly if it is not run under its specific design conditions.

10.5.2 Aspects to Consider:

In operating a commercial scale dryer such as a continuous through-circulation dryer, keep in mind the following points:

No matter what you do to try to duplicate drying on a small scale, nothing can be done to reproduce actual conditions during commercial production.

Small scale trials in lab units impose wall effects and fail to duplicate air flow patterns (Note: some dryer types are scaleable).

Lab tests can give very good information about the drying properties of the material itself on an individual "chunk" or particle basis.

e.g.: TGA - thermal gravimetric analysis can detail how moisture loss proceeds with temperature and time

DSC - differential scanning calorimetry can show how properties of a material change over time as heat is applied

To assess the true operating capacity of a dryer, you need to have a test sequence that includes overall water removal and water removal uniformity across and along the dryer bed.

Single or even multiple grab samples of product cannot provide sufficient data as to a dryer's overall operation. We will

discuss this more in the next module on "Process Control in a Drying Operation".

We will look at a relatively simple method of determining the uniformity of drying together with the water removal capacity of a dryer later in this chapter.

10.6 Assessing Uniformity

10.6.1 An Approach to Water Removal Capacity and Drying Uniformity Determination:

“Water removal capacity” can be defined as:

The amount of water a dryer is capable of removing from a given product in a given period of time (usually per hour).

Factors influencing the water removal capacity of a dryer include:

- characteristics of the product to be dried
- characteristics of the product bed (on the dryer belt)
- condition of the dryer
- age of the dryer
- characteristics of the drying air
- etc.

You cannot always rely on the manufacturer’s rated capacity of the dryer.

Manufacturers of dryers build their equipment to deliver a certain level of performance that can be demonstrated when the dryer is newly installed. With age and other factors, the performance of the dryer can change. Insulation in the dryer can deteriorate and more heat can be lost when the dryer is old than when it was new. Burner performance can deteriorate over time and processors can even change things on

their own without the manufacturer’s knowledge.

One method of determining how much water the dryer is actually capable of removing and to determine how uniform the drying is, is to do a series of simple tests.

Imagine yourself standing at the discharge end of a conveyor belt dryer with the dried product coming towards you. The bed of dried product may be two or three metres wide and will fall off the belt into a collection hopper of some description just in front of you. What you want to do is determine the uniformity of moisture across the dryer bed. If you do this at a series of time intervals, you can also determine the uniformity in moisture over time.

A procedure that I have used is to take a set of six samples across the end of the dryer at a particular time. Two other helpers are needed to get the samples at the same time. Each sample is placed into a labelled plastic bag and tied for future testing. The time of these samples will be “Time $t = 0$ ”. Five minutes later, a second set of samples is taken at the same six locations and are labelled “Time $t = 5$ minutes”. Five minutes later, a third set of samples labelled “Time $t = 10$ minutes” is taken; and five minutes after that, a fourth set of samples labelled “Time $t = 15$ minutes” is taken. Each sample is then tested for moisture using a recognized moisture determination method.

Figure 10-3 shows how the sampling pattern would look.

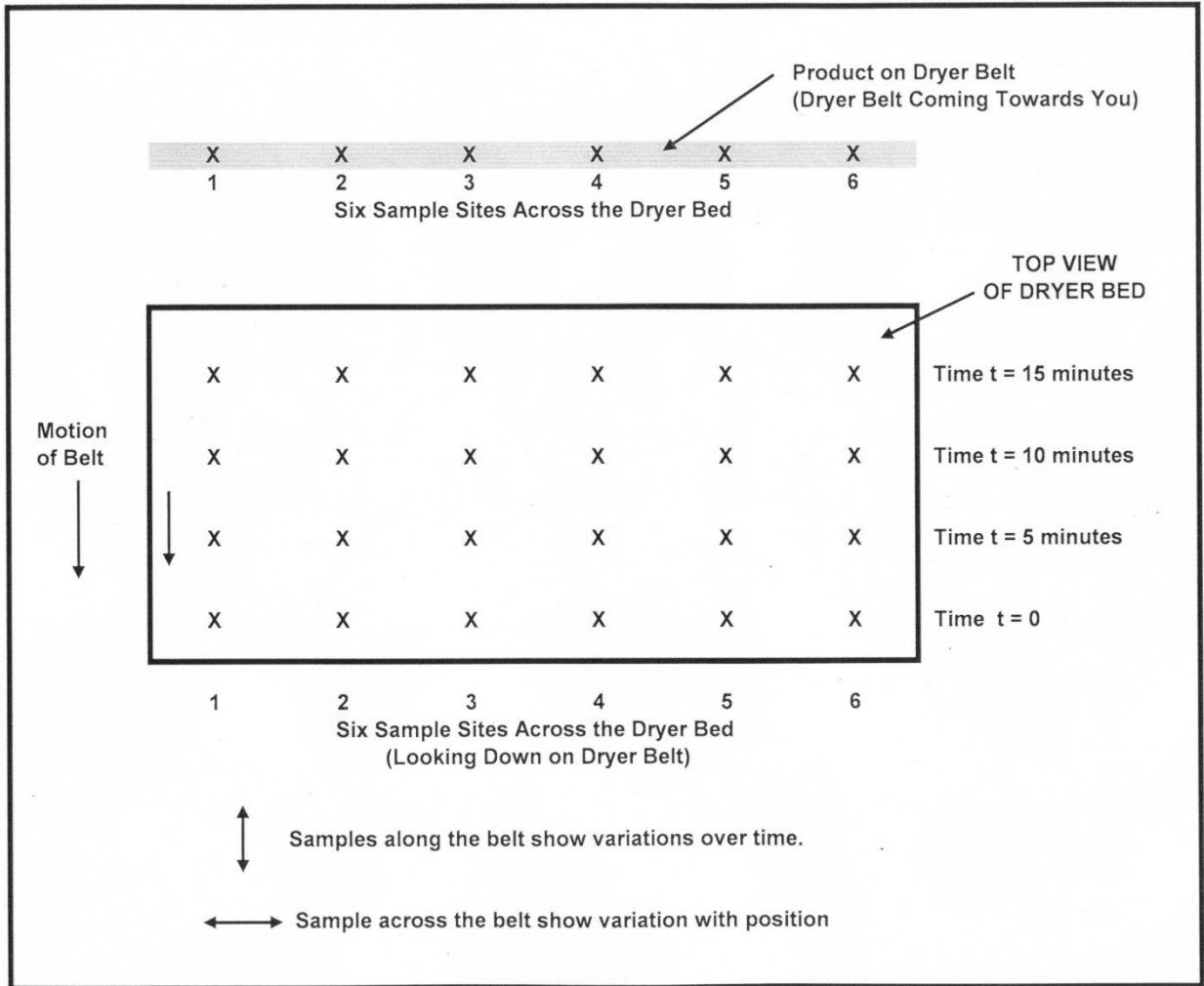

Figure 10-3: Sampling pattern for determining water removal capacity and uniformity of drying

The results of the 24 moisture tests, in what is referred to as "Scenario 1", are then arranged in a table format such as that shown in Table 10-1. The first set of samples is in the bottom row to duplicate the view of the dryer bed as if seen from above. Averages of moistures are calculated across each row of six samples and along each group of four samples taken at each sample site. The overall average for the 24 samples is also calculated.

In order to get some idea of the variation or spread of the moisture results, standard deviations are also taken for each row of six samples, each set of four moistures from each sample location, and for the entire 24 samples.

While it is recognized that a standard deviation based on four samples may not be statistically valid, the objective is to have the standard deviation as small as possible to indicate a low degree of variability among any set of sample results. The standard deviation is

essentially used as a tool for qualitative purposes.

In Table 10-1, we can see the individual moisture values and the calculated averages and standard deviations. It appears as if the product along the left side of the dryer (average moisture = 6.1%) is much dryer than that along the right hand side of the dryer (average moisture in position 5 = 20.2% and in position 6, average moisture = 19.3%). The degree of variation in the moistures is also lower on the left hand side of the dryer than it is on the right hand side.

The average moisture across the dryer is reasonably uniform over time. It ranges from an average of 13.3% to 15.3%. The overall average moisture for the 24 samples was found to be 13.9%. If our target moisture is 12.0% and we have an acceptable range of $\pm 2.0\%$, a moisture value between 10.0% and 14.0% would be considered acceptable.

On the basis of these results, the average moisture of 13.9% would be

acceptable, but this does not tell the whole story. There are individual moistures as low as 5.4% and as high as 27.1%. These are certainly outside the range of acceptability. From our experience, we may know that mold can grow on our product if moisture levels rise beyond a certain threshold level. For this example, let's consider that value to be 20% moisture.

A chart of confidence limits has also been included as part of Table 10-1. With an overall standard deviation of 5.66% wet basis moisture and 99.7% confidence limits, we know that the moisture will lie in a range of three standard deviations below the mean to three standard deviations above the mean. This tells us that moisture levels will lie between -3.07% (this is impossible, so we'll call it 0%) and 30.90%.

Basically, Table 10-1 is really telling us that we have widely fluctuating moisture contents in our product, and our dryer is not functioning very uniformly at all.

TABLE 10-1: Scenario #1: Initial Moisture Profile Along and Across the Dryer

Time	Position 1	Position 2	Position 3	Position 4	Position 5	Position 6	Average Std. Dev.
15 min.	6.6	11.3	14.3	14.2	17.1	18.9	13.7 4.37
10 min.	5.4	10.4	13.2	15.3	20.1	15.3	13.3 5.00
5 min.	6.1	5.9	13.9	13.5	25.2	27.1	15.3 9.12
0 min.	6.4	11.7	13.0	14.7	18.5	15.8	13.4 4.14
Average Std. Dev.	6.1 0.53	9.8 2.67	13.6 0.61	14.4 0.76	20.2 3.54	19.3 5.45	13.9 5.66

Confidence Limits	Standard Deviations	Average Moisture	Range
68.3%	± 1.0	13.9%	8.24% to 19.56%
95.0%	± 1.96	13.9%	2.82% to 25.01%
95.5%	± 2.0	13.9%	2.59% to 25.23%
99.7%	± 3.0	13.9%	-3.07% to 30.90%

All moisture values are expressed as percentages (%) on a weight basis

Note: Target moisture = 12.0% ± 2.0%

The use of standard deviations with only four or six data points has serious statistical deficiencies. They are used here to show directional or qualitative trends and aid in the assessment of overall dryer performance.

Large standard deviation values indicate a wide scatter of the data. Low standard deviations show a small degree of scatter in the data.

Now let us suppose that we do major modifications to our dryer. Perhaps we find that there are no air distribution plates in it; so we install some, etc.

We now repeat our set of tests under similar operating conditions and tabulate the results. Table 10-2 shows the data from the tests done after the dryer modifications were made.

TABLE 10-2: Scenario #2: Second Moisture Profile Along and Across the Dryer

Time	Position 1	Position 2	Position 3	Position 4	Position 5	Position 6	Average Std. Dev.
15 min.	11.2	11.8	12.3	12.2	12.6	12.2	12.1 0.49
10 min.	11.4	11.6	11.9	12.1	13.0	11.9	12.0 0.56
5 min.	11.3	11.4	12.1	12.1	12.7	11.7	11.9 0.52
0 min.	11.5	11.4	12.0	12.4	12.5	12.3	12.0 0.47
Average Std. Dev.	11.4 0.13	11.6 0.19	12.1 0.17	12.2 0.14	12.7 0.22	12.0 0.28	12.0 0.48

Confidence Limits	Standard Deviations	Average Moisture	Range
68.3%	± 1.0	12.0%	11.50% to 12.46%
95.0%	± 1.96	12.0%	11.04% to 12.93%
95.5%	± 2.0	12.0%	11.02% to 12.94%
99.7%	± 3.0	12.0%	10.54% to 13.43%

All moisture values are expressed as percentages (%) on a weight basis

Note: Target moisture = 12.0% ± 2.0%

The use of standard deviations with only four or six data points has serious statistical deficiencies. They are used here to show directional or qualitative trends and aid in the assessment of overall dryer performance.

Large standard deviation values indicate a wide scatter of the data. Low standard deviations show a small degree of scatter in the data.

We can see that average moistures across the product bed range from 11.4% to 12.7%, with very low standard deviations (0.13% to 0.28%). Average moistures over time range from 11.9% to 12.1% and the standard deviations range from 0.47% to 0.56%. This shows a great improvement over the first test results.

Now, if we take the mean of 12.0% plus or minus three standard deviations, we can say with 99.7% confidence that the moisture of any sample taken from the dryer will lie between 10.54% moisture and 13.43% moisture. Since this moisture range is within our allowable moisture range of 10.0% to 14.0% moisture and our average moisture value (i.e., 12.0%) is right on the target value of 12.0%; we can say that the dryer is operating well and moisture fluctuations are acceptable. Examining the actual moisture values, there are no data points which are outside of the acceptable range. We may still want to work on the dryer to improve its operation, but we are certainly in much better shape now than we were originally.

In order to determine the water removal capacity of the dryer, we should do a series of similar tests using different water loadings for the dryer. We could increase the moisture content of the wet product entering the dryer and determine the moisture of the product leaving the dryer. Once the dryer is no longer able to remove the necessary amount of water to give us an average moisture that is within our specifications, we can say that the dryer has exceeded its water removal capacity.

10.6.2 Summary of Points for Water Removal Capacity Determination:

You should begin by conducting a series of tests similar to those outlined in Table 10-1 to establish a bench-mark for how the dryer is operating under current conditions.

You can run this procedure under increasing moisture loads and determine at what point the dryer fails to meet the desired target moisture and uniformity.

THE MAXIMUM DRYER CAPACITY IS THE POINT AT WHICH THE DRYER LAST MEETS THE PERFORMANCE CRITERIA.

To establish an operating capacity for a dryer, you may want to operate at about 90% of the maximum water removal which you determined. This will allow some extra capacity in the event of an emergency and does give an added range of control.

In actual fact, many processors seem to operate a dryer at 110% (or more) of its rated or designed maximum water removal capacity. In spite of demanding that the dryer perform above its design capacity, the operators still want the dryer to function perfectly and to still be capable of handling any "spikes" of high moisture in the incoming product.

As stated previously, the typical approach is to turn up the burners and maximize the volumetric air flowrate. The dryer belt can then be sped up to make a thinner bed of material or slowed down to make a thicker bed but give the material more exposure time. Regardless of the approach, the results are always the same - catastrophic. To

make matters worse, the dryer manufacturer usually bears the brunt of the unjust blame.

10.6.3 Typical Problems:

If a dryer is not operated properly, the following problems can be expected:

- wet pockets of material (mold growth may occur in the product later)
- toasting / browning of product
- case hardening + wet centres of particles. This means that the outside of the product is dried to form a hard crusty shell around a moist wet centre of the material. Water cannot readily escape and is caught inside the case-hardened particle.
- stress cracking due to uneven moisture or temperature profiles in a product particle
- holes in dryer bed due to air lifting the product
- dry top and bottom of material bed but wet centre layer
- non-uniformity of drying between product on one side of the dryer and the other
- poor final product performance due to changes in product properties and functionality
- economic losses (fuel and product waste)

10.7 Changes in Moisture After Drying:

If poorly dried product is packaged, the following problems may arise. The actual packaging material will certainly have an impact on how the product is affected during storage.

- Establishment of equilibrium with ambient atmosphere: You want the product to be dried to a level of moisture that is as close as possible to the moisture at which it will be stored. In this way, the product will not experience excessive moisture losses or gains that can alter its properties and performance.
- Moisture equilibrium of stored or packaged product: You do not want to have excessively wet and dry product in the same package. Moisture changes during storage will affect the product in a negative manner.
- Structural collapse (if improperly processed): Moist product may be soft and collapse in on itself as it dries in the package.
- Spoilage: Mold growth can result if moisture levels are excessive.
- Product shrinkage: Some products actually begin to “shriveled up” if they dry slowly under uncontrolled conditions.

- Nutritional degradation: Nutrients can be lost during storage due to excessive moisture levels.

10.8 Controlling Drying Processes:

10.8.1 Basic Approach to Process Control:

Process control does not have to be a series of complicated equations and confusing theory. Most of us are only interested in knowing whether or not we are meeting our finished product specifications. If our finished product is “in spec”, then we also want to know what we need to do to keep it that way.

Process control can be very simple and straight-forward when we are working with home food dehydrators. These units dry product in single batches and usually only allow the user to adjust the temperature of the drying air. As long as the heating coils keep the air at the proper temperature, there is very little that has to be done beyond monitoring the drying and removing the product once the desired final moisture (or drying time) has been reached. The time taken to reach the desired final moisture will depend on a number of factors related to the initial product, such as its moisture content, and dimensions, etc.

It is when larger continuous dryers are used that controlling the process becomes more demanding.

When drying a product, most processors have a target moisture which they want to achieve for optimum quality or product performance. Recognizing that it is not always possible to “hit” this

target moisture at all times, an acceptable moisture content range can be established. If the moisture lies within this range, then the finished product can go on to other steps in the process or be packaged for shipment to the consumer. If it is outside this range, then the product should be considered “out of spec” (i.e., outside of specifications), and it should not be sold.

Let’s consider a product whose optimum moisture content is 12% on a wet basis. Through various evaluation procedures, it has been found that the product is still quite acceptable if its moisture content is as low as 10% and as high as 14%. Therefore, we can set the specifications for moisture as being 12% plus or minus 2%. The acceptable range can also be

written as $12\% \pm 2\%$, as shown earlier in this chapter.

A process operator needs to monitor the moisture of the finished product regularly during the drying process to ensure that the specifications are being met.

Figure 10-4 shows the moisture content of product from a process during a 12 hour time period. Here, the moisture content is plotted versus time. The target moisture as well as the upper and lower acceptable limits are indicated by horizontal lines labelled in the diagram. As can be seen, the moisture fluctuates slightly, but never rises too far above nor falls too far below the target moisture. It does not go beyond the acceptable limits at any time during the 12 hour drying time.

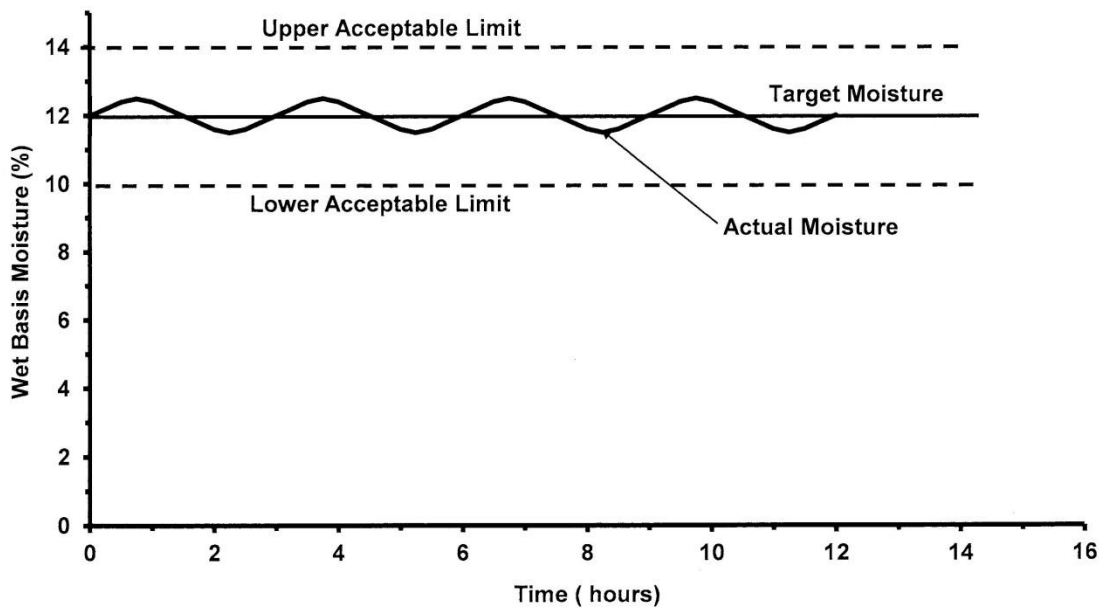

Figure 10-4: Moisture content of a product during a 12 hour drying period

As long as the process continues to function in this manner, there is no need for the operator to take any action to adjust the conditions inside the dryer.

The question as to when action should be taken to make adjustments to the drying conditions is an extremely important one. Some operators may consider that as long as the moisture content is not outside the specified range, no remedial steps are required. Other operators may look at moisture trends and decide that if the moisture continues to go upwards or downwards, it will soon go out of the specified range. They may then make small adjustments in an attempt to bring the moisture back towards the target value.

fluctuation of the moisture above and below the target. We can then ask ourselves the question as to when it would be appropriate for the dryer operator to make an adjustment. In order to put some actual values on this, we can impose some “control limits”.

“Control limits” tell the operator when to make changes to the dryer settings. There will be an “upper control limit” and a “lower control limit”. The upper control limit will be established at a point between the target moisture and its upper acceptable limit. The lower control limit will be set at a point between the target moisture and the lower acceptable limit as shown in Figure 10-5.

If we look at Figure 10-4 once again, we can see that there is a regular

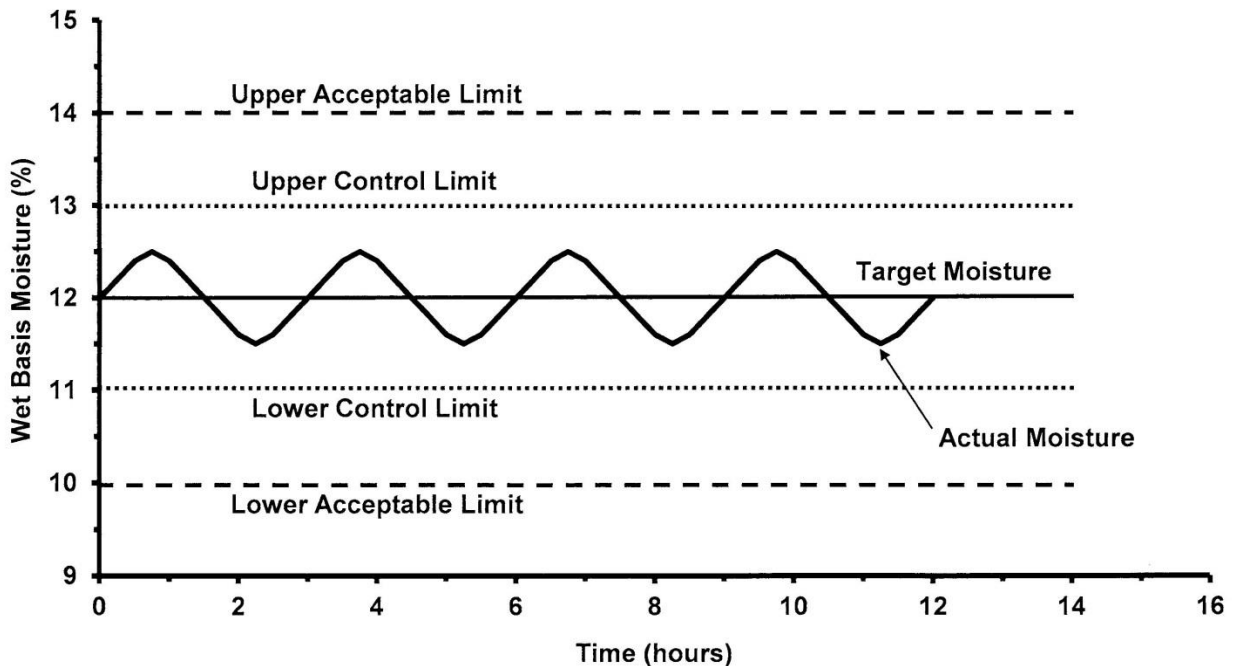

Figure 10-5: Upper and lower control limits on a food drying process

The control limits in Figure 10-5 have been placed at the half-way point between the target moisture and the limits of the acceptable moisture range. This is not necessarily the way it must be. What is important is to have the operator respond to changes in moisture content while it is still within the acceptable range so that the effects of the remedial action can take place before the moisture content goes “out of spec”. In this way, it will be possible to bring the moisture back closer to the target moisture and reduce the risk of making product that is either too wet or too dry.

10.8.2 Feed Forward and Feed Back Control:

For the sake of completeness, I would like to take a quick look at one of the process control mechanisms used in food drying. The discussion will apply to continuous dryers.

There are only a few components that can be controlled during a drying process in order to respond to changes in the moisture content of the product leaving the dryer. Since we generally cannot do anything about the nature of the material in the dryer once the drying is underway, we are left with being able to make adjustments to the temperature of the air; the velocity of the air; the retention time in the dryer; and the amount of feed being introduced into the dryer on an hourly basis.

When working with large continuous dryers, it may be very difficult (or even impossible) to change the volumetric flow rate of the air coming into the drying chamber, which affects its linear velocity. These changes may require

shutting down the dryer if there are not variable speed motors on the fans supplying air to the dryer.

The residence time in a continuous through-circulation dryer can be changed by altering the speed of the conveyor belt. Speeding up the belt will reduce the retention time, and slowing it down will increase the retention time. If there is an automatic feed mechanism on the dryer, the thickness of the material bed can change. It will get thicker if the belt slows down and thinner if the belt speeds up.

If the feed rate can be adjusted, it can be used to keep the bed thickness constant when the belt speed is changed. The feed rate can also be used independently of the belt speed to increase or decrease the rate at which material is introduced into the dryer. This will increase or decrease the water removal demands on the dryer. As a result the finished product moisture will respond accordingly.

The easiest response to take is adjusting the temperature of the drying air. However, care must be taken not to use temperatures that are too high. Thermal damage or case hardening can result from excessively high temperatures.

For example purposes, let’s look at using temperature adjustments to correct for moisture fluctuations in the dryer. A continuous through-circulation dryer with three zones will be used. Temperatures of the air to each zone can be controlled by adjusting the amount of natural gas going to each set of burners in the dryer.

The first thing that we need to have is a reliable indication of the moisture content of the material leaving the dryer. We can then take action based on these values. If the moisture content is too high, the air temperature to any or all zones of the dryer can be raised by increasing the amount of natural gas going to the appropriate burners.

A continuous moisture monitoring device on the discharge end of the dryer

will provide the necessary information to a computer which is programmed to control the burners. Since this method involves taking a signal from the end of the process and feeding it to devices that are behind it (or upstream) in the process, we call this a “feed-back” control method.

Figure 10-6 shows a feed-back control system for a drying process.

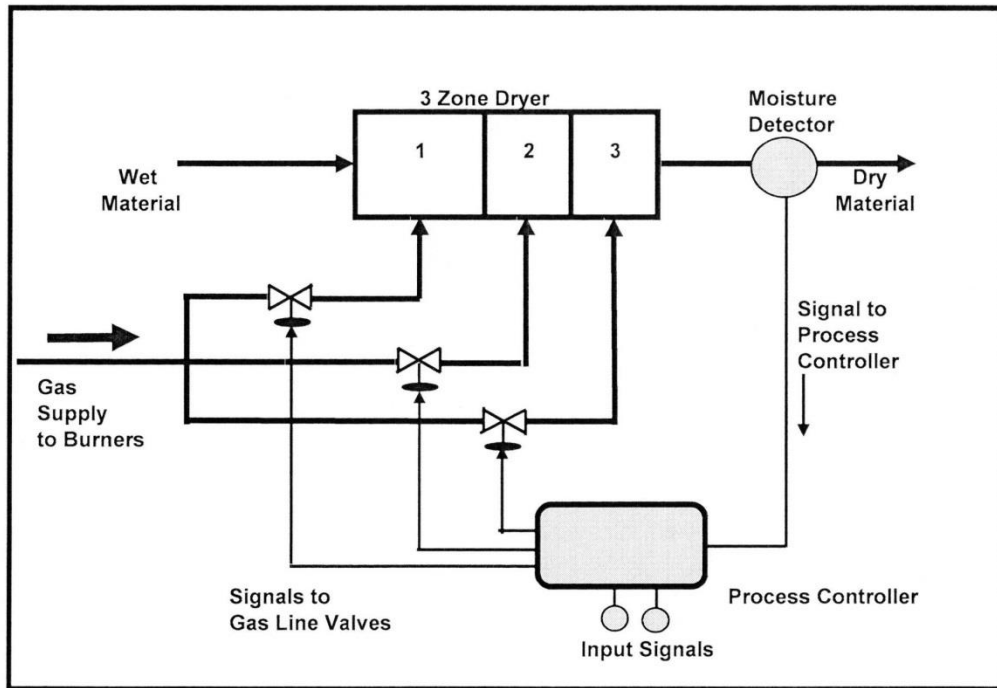

Figure 10-6: Feed-back control in a dryer system

If we look at the feed-back control method more closely, we can see that it is actually basing our actions on product that has already been dried and is leaving the dryer. The short-coming of this approach is that we are always making adjustments after the problems have occurred. Even when remedial action is taken, there will be a delay before we can see any results coming out of the dryer. It would be far better if we could look at the moisture of the material coming into the dryer and plan our actions accordingly.

In feed-forward control, the moisture of the incoming feed material is continuously monitored in the same way it was done with feed-back control. The big difference now is that we can anticipate problems in the dryer before the feed enters. If the moisture content rises, the temperature of the air in the first zone can be increased to compensate for it. If the moisture content goes down, a corresponding decrease in the temperature of the air supplied to the first zone can be made.

Figure 10-7 shows a feed-forward approach to moisture control.

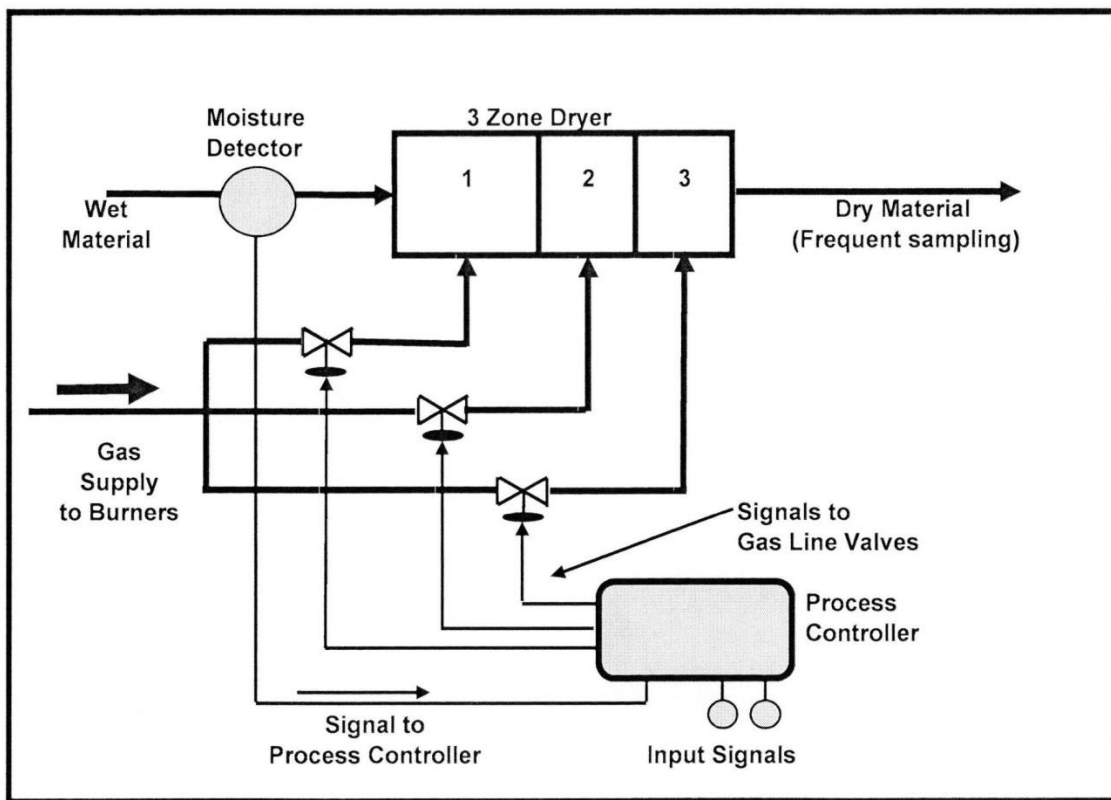

Figure 10-6: Feed-forward control in a dryer system

Perhaps the best arrangement would be to have both feed-forward and feed-back control. This would tell you what was coming into the dryer and allow appropriate actions to be taken. In addition, it would tell you what the results of these actions were at the other end of the dryer. There is a time factor to consider here due to the residence time in the dryer. Any adjustments based on the incoming feed

moistures will not be evident until this feed has gone through the dryer, which may take thirty minutes or more, depending on the dryer.

Figure 10-7 shows a dryer equipped with both feed-forward and feed-back controls for moisture.

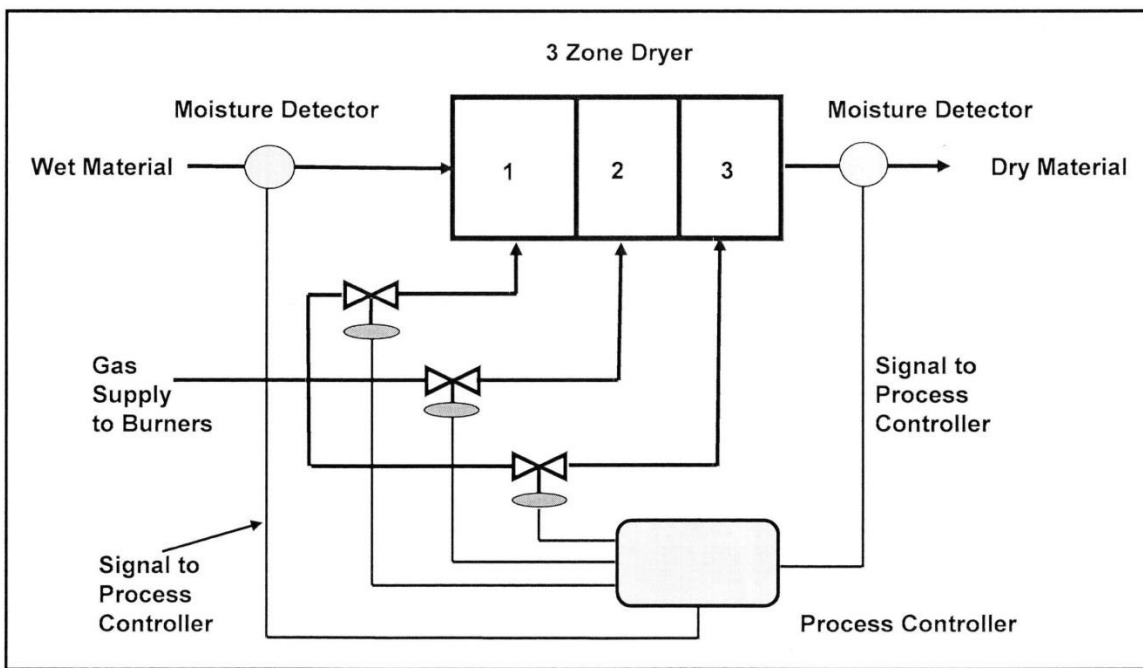

Figure 10-7: Feed-forward and feed-back controls in a dryer system

10.9 Factors to Remember About Product Drying:

Once you have established a dryer's water removal capacity and have optimized its performance, there are still some things to keep in mind:

- Every product has its own drying characteristics.
- In the case of agricultural crops, there will be crop to crop variation and seasonal changes based on fresh versus stored material:
- There may be years when kernels of grain are quite large and plump. In other years the kernels may not be as plump. This difference in diameter can affect how fast the grains take up water in a hydration process and how fast they lose water in a drying process.
- You must always be aware of the characteristics in your product to be successful in any drying operation.

11: DRYING KINETICS OF FRUITS AND VEGETABLES

11.1 Introduction:

Up to this point, we have primarily looked at drying from the perspective of dryer design and functioning as well as doing calculations related to the moisture content of various products.

In Chapter 8, we briefly touched on calculating the rate at which water was removed from a sample of hot yellow peppers. In this chapter, we will expand upon the basics established in Chapter 8 in order to provide a much deeper understanding of how fast water is being lost from various products under different conditions of drying or with different preparation of the materials. We refer to this as the drying “kinetics”.

11.2 Basic Drying Kinetics

Let's consider an example with hot yellow peppers sliced lengthwise into eighths. As with the quartered peppers we examined in Chapter 8, the air temperature of 50°C and air velocity of 0.5 metres per second in a laboratory dryer have been maintained.

Based on an initial wet basis moisture content of 93.26% (wet basis), the initial dry basis moisture was calculated as being 13.84 grams of water per gram of dry solids. By following the weight of the peppers in the dryer, the dry basis moisture was calculated at fifteen minute intervals for nineteen hours. From these calculations, a graph of dry basis moisture versus time was prepared. It appears as Figure 11-1.

Chapter 11:
An Introduction to the Dehydration and Drying of Fruits and Vegetables

Donald G. Mercer, Ph.D., P.Eng., FIAFoST
Department of Food Science
University of Guelph
Ontario, Canada
ISBN 978-0-88955-621-8
© 2014

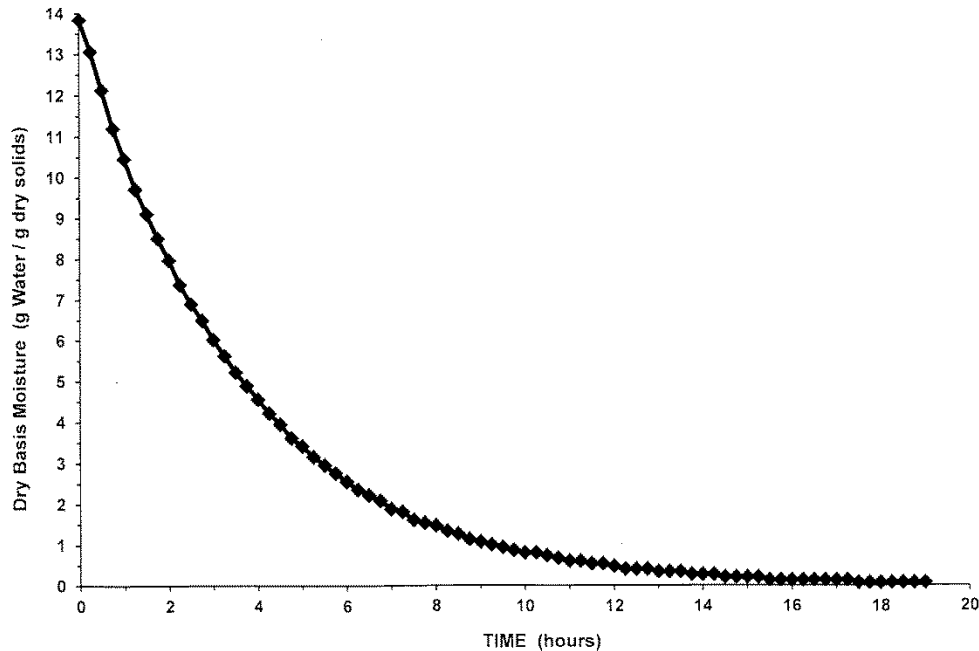

Figure 11-1: Dry basis moisture versus time for sliced hot yellow peppers

It should be emphasized that the kinetic studies of how a food dries are not exactly the same as for the drying of a product for commercial purposes. When drying a product for sale, it is important to achieve a final moisture content, within an acceptable range. For example, your target may be 10% wet basis moisture with an acceptable tolerance of $\pm 2\%$, meaning that a final moisture level in the range of 8% to 12% would meet your final product specifications. However, in order to obtain a mathematical equation for the rate at which water is removed, it is advisable to dry the material until it is completely dry, or as close to it as possible. While this essentially amounts to over-drying the product, it provides valuable information for use in determining the material's overall drying kinetics. The kinetic model will then serve as a more reliable predictive tool than it would have done if information

from the final stages of drying had not been included.

In Figures 8-6 and 8-7, we showed how to calculate the rate of water removal during the initial constant rate drying period and the falling rate drying period, respectively. However, it would be more useful if we could develop a mathematical relationship between the dry basis moisture content of the peppers with respect to time during the full duration of the drying run. Fortunately for us, most spreadsheet applications allow us to do just that by fitting various curves to the experimental data we have collected.

In the work done in our lab, Microsoft Excel[®] spreadsheets were used for all data manipulations and calculations, with excellent results. We will not explain the details of using

spreadsheets to develop equations for curves.

Briefly, once you have prepared the desired graph, you use the “trendline” feature in the spreadsheet package. By trial and error, you can select the type of curve, (e.g., linear, exponential, logarithmic, polynomial, etc) that will best fit your data.

The R-squared value (or correlation coefficient) which can be displayed will provide you with an indication as to how well the experimental data fit the curve

which has been drawn through them. Even if you feel intimidated by mathematics, you should give this a try since it is a quite user-friendly method of obtaining mathematical equations to fit your data.

Figure 11-2 is a slightly modified version of Figure 11-1. It shows how a straight line and an exponential curve have been selected in an attempt to predict an equation for the dry basis moisture versus time in the drying of the pepper slices.

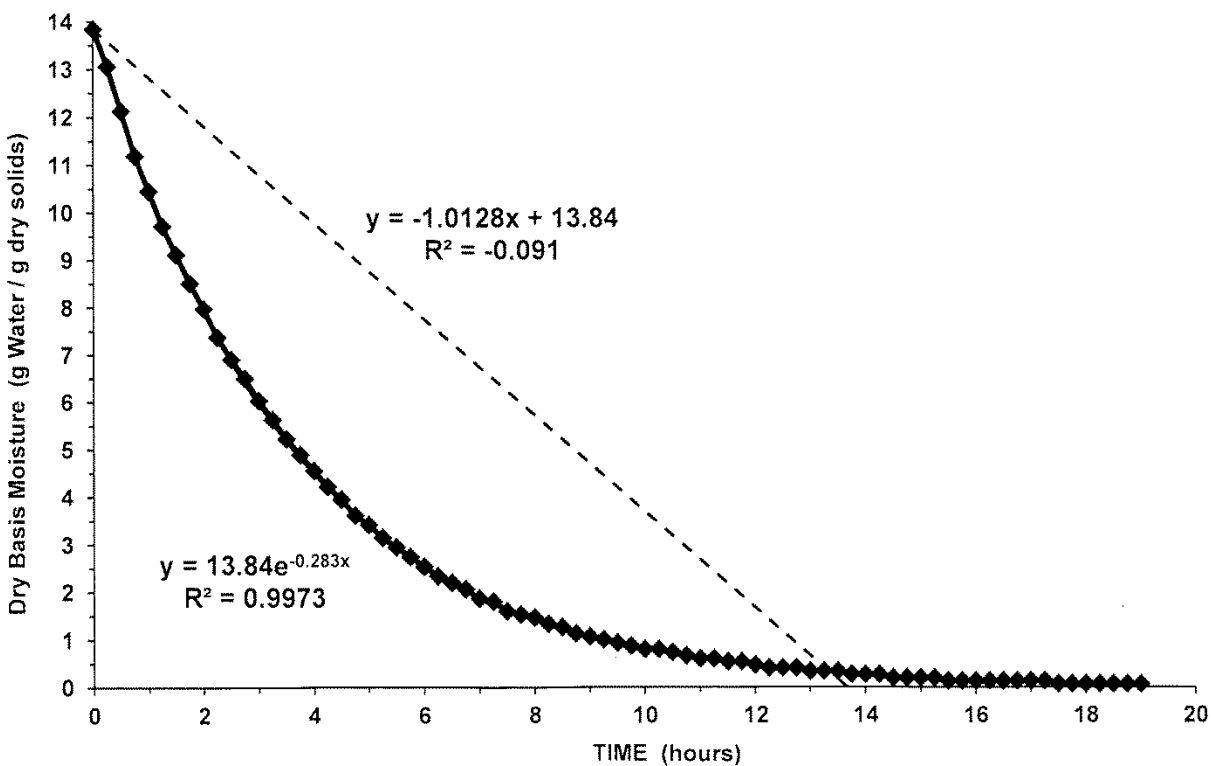

Figure 11-2: Linear and exponential curve fitting for drying of hot yellow peppers (pepper cut into eighths lengthwise)

In Figure 11-2, the straight line for the linear curve fitting generated by the Excel spreadsheet gives the following equation:

$$y = -1.0128x + 13.84$$

where: y = dry basis moisture
 x = time (in hours)

The value 13.84 is the initial dry basis moisture with units of grams of water per gram of dry solids.

The value -1.0128 indicates the rate of moisture loss in units of grams of water per gram of dry solids per hour. Please take special note of the negative sign which indicates that there is a moisture loss here. If there was a gain in moisture, there would be a positive sign in front of the numerical value preceding the x .

If we compare the straight dashed line for the linear curve in Figure 11-2 with the curve for the actual data, we can see that the fit is extremely poor. The straight line only contacts the data curve at time “zero” and at about 13.5 hours into the run. The R-squared (i.e., R^2) value of -0.091 quantifies just how poor this fit really is. A perfect fit of the data to the predicted curve would have been 1.0000.

The fit of the straight line to the experimental data is so poor that the spreadsheet value of R^2 is entirely improbable and truly impossible. As you may know, the square of any value, whether positive or negative, always results in a positive value. There is really no way in which an R^2 value of -0.091 should arise. We simply need to accept the fact that this is how the spreadsheet displayed the poor degree

of fit and dismiss the straight line as being totally unacceptable for our purposes.

Also shown in Figure 11-2 is an attempt to fit an exponential curve to the experimental data. It has the equation:

$$y = 13.84 e^{-0.283x}$$

where: y = dry basis moisture
 x = time (in hours)
 e = exponential operator

The value 13.84 is the initial dry basis moisture with units of grams of water per gram of dry solids.

The value -0.283 is a rate constant with units of reciprocal hours (i.e., hours⁻¹ or 1/hours). Once again, the negative sign which indicates that there is a moisture loss here. If there was a gain in moisture, there would be a positive sign in front of the rate constant preceding the x . The greater the absolute value of the rate constant (i.e., ignoring the negative sign), the faster the moisture loss will be.

Since the R^2 value is 0.9973, the fit of the predicted curve to the experimental data is extremely good. This is obvious by how well the dashed line lies on of the curve for the experimental data in Figure 11-2. There are no regions where there is any visible deviation between the predicted curve and the experimental data.

We can now use the exponential equation for the drying process to predict the moisture at any time up to sixteen hours. The linear equation is essentially useless and should simply be discarded and forgotten.

11.3 Using Kinetic Equations

Let's assume we want to find the moisture content of these narrow pepper slices after they have been in the dryer for 10 hours. Taking the predictive kinetic equation from above, we have:

$$y = 13.84 e^{-0.283x}$$

Personally, I think it is more convenient to let the time be represented by "t", so let's make that change in our kinetic equation:

$$y = 13.84 e^{-0.283t}$$

If the time is 10 hours, we can substitute the value 10 for t so that we get:

$$y = 13.84 e^{-2.83}$$

We can now start solving this equation using a calculator.

$$y = 13.84 \times 0.0590$$

$$y = 0.81656 \approx 0.817$$

Therefore, after ten hours of drying, the dry basis moisture would be expected to be about 0.817 grams of water per gram of dry solids, which is equivalent to about 45.0% wet basis moisture.

$$\begin{aligned} \text{i.e., } & \frac{0.817 \text{ g water}}{1.817 \text{ grams total weight}} \times 100\% \\ & = 45.0\% \end{aligned}$$

Suppose we want to calculate the time it takes for these hot yellow pepper slices to reach a moisture content of 75% wet basis moisture.

The first thing we need to do is convert the wet basis moisture to its dry basis

equivalent. We will base this calculation on 100 grams of wet material.

$$\begin{aligned} 75\% \text{ moisture} &= \frac{75 \text{ g water}}{25 \text{ g dry solids}} \\ &= 3.0 \text{ g water / g dry solids} \end{aligned}$$

Looking at the predictive equation, with "t" for time:

$$y = 13.84 e^{-0.283t}$$

We need to rearrange the equation to solve for t:

$$e^{-0.283t} = y / 13.84$$

Taking the ln of both sides:

$$-0.283 t = \ln(y / 13.84)$$

We know that y is equal to 3.0 g water per g dry solids. So:

$$-0.283 t = \ln(3.0 / 13.84)$$

$$-0.283 t = \ln(0.2168)$$

$$-0.283 t = -1.529$$

$$t = (-1.529) / (-0.283) = 5.40$$

Therefore, the required time is 5.4 hours for the peppers to reach 75% wet basis moisture. This time is consistent with what we see on the graph in Figure 11-2.

Now, let's try another calculation. If our target moisture for the peppers is 10% on a wet basis, we should be able to calculate the time taken under these conditions to reach that goal.

Once again, the first thing we need to do is convert the wet basis moisture to its dry basis equivalent. We will base this calculation on 100 grams of wet material.

$$10\% \text{ moisture} = \frac{10 \text{ g water}}{90 \text{ g dry solids}}$$

This gives us 0.111 g water / g dry solids.

Looking at the predictive equation, with "t" for time:

$$y = 13.84 e^{-0.283t}$$

We need to rearrange the equation to solve for t:

$$e^{-0.283t} = y / 13.84$$

Taking the ln of both sides:

$$-0.283 t = \ln (y / 13.84)$$

We know that y is equal to 0.111 g water per g dry solids. So:

$$-0.283 t = \ln (0.111 / 13.84)$$

$$-0.283 t = \ln (0.00802)$$

$$-0.283 t = -4.826$$

$$t = (-4.826) / (-0.283) = 17.05$$

Therefore, the required time is approximately 17.1 hours for the sliced peppers to reach 10% wet basis moisture. This time is consistent with what we see on the graph in Figure 11-2. It should be noted that it is difficult to get an accurate value from the graph itself. Using the equation provides us with a much clearer indication of the time required for the drying process.

One of the things that many students find bothersome is the use of significant figures. When working with these calculations, I tend to carry an excessive number of decimal points during the intermediate steps and only round-off the final answer once it has been calculated. It is best not to get too "hung up" on significant figures in applications such as these.

11.4 Comparing Drying Kinetics

There will be many times when you want to compare the drying of two or more samples but you find that they do not have exactly the same initial moisture content. Using multiple runs is particularly important in obtaining a statistically representative view of how materials dry. Multiple samples allow you to calculate an average behaviour and rule out any abnormal data which otherwise might have gone unnoticed.

Figure 11-3 shows the dry basis moisture versus time for three drying trials of hot yellow peppers cut lengthwise into quarters. They were

dried at 50°C with an air velocity of 0.5 metres per second. These three runs used different pepper samples from the one shown in Figures 11-1 and 11-2. It can be seen that the starting moistures in each run are slightly different due to what we expect as normal sample variations. Initial dry basis moistures for the three runs were 12.66, 13.10, and 13.29 grams of water per gram of dry solids.

Although the curves in Figure 11-3 have the same basic shape, it is difficult to do an actual comparison since they all have a different starting point on the vertical axis.

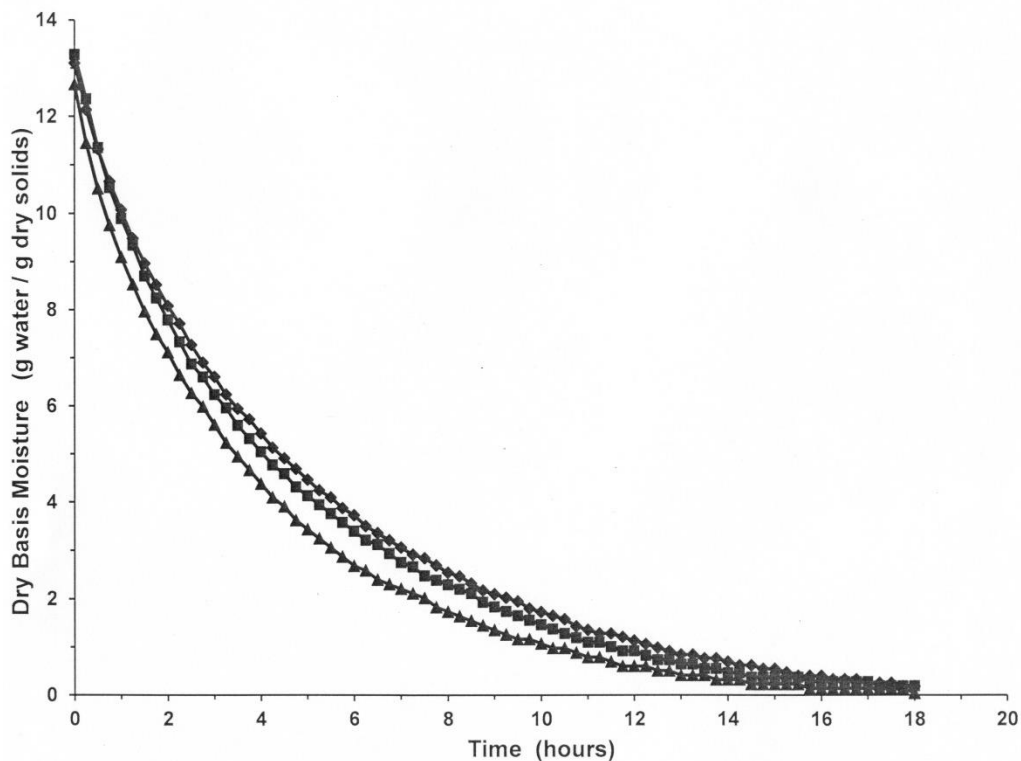

Figure 11-3: Results of three drying trials of quartered hot yellow peppers

The exponential equations for each of the curves in Figure 11-3, beginning with the upper-most curve, are:

$$y = 13.29 e^{-0.231 t} \quad (R^2 = 0.9946)$$

$$y = 13.10 e^{-0.216 t} \quad (R^2 = 0.9895)$$

$$y = 12.66 e^{-0.265 t} \quad (R^2 = 0.9850)$$

where: y = dry basis moisture
 t = time in hours.

The numerical values 13.29, 13.10, and 12.66, indicate the dry basis moistures of the starting material in each case, with units of grams of water per gram of dry solids.

In order to do a comparison of these three runs, we need to resolve the issue of having different starting points. This can be accomplished by taking the individual dry basis moistures over the duration of each drying trial and dividing them by the initial dry basis moisture content of the starting material. The result is referred to as a “moisture ratio”, which is a dimensionless ratio of the dry basis moisture at any time “ t ” relative to the initial dry basis moisture of the material.

$$\text{Moisture ratio} = M / M_0$$

where: M = dry basis moisture at time t
 M_0 = initial dry basis moisture

When this is done, the moisture ratio of the starting material will be 1.00.

Figure 11-4 shows the moisture ratio versus time for the three quartered pepper runs plotted in Figure 11-3. It can be seen that all curves have a value of 1.00 for time “zero”. Notice how the positions of the curves relative to each other have remained the same. However, since they have the same initial point, it is easier to do a comparison of them.

The exponential equations for each of the curves in Figure 11-4, beginning with the upper-most curve, are:

$$y = 1.00 e^{-0.231 t} = e^{-0.231 t}$$

$$y = 1.00 e^{-0.216 t} = e^{-0.216 t}$$

$$y = 1.00 e^{-0.265 t} = e^{-0.265 t}$$

y is now the dimensionless moisture ratio in each case.

The values of the rate constants for each trial remain unchanged in the conversion from the dry basis moisture versus time graph to the moisture ratio versus time graph. The numerical value “1.00” can be omitted in each of these equations as shown above.

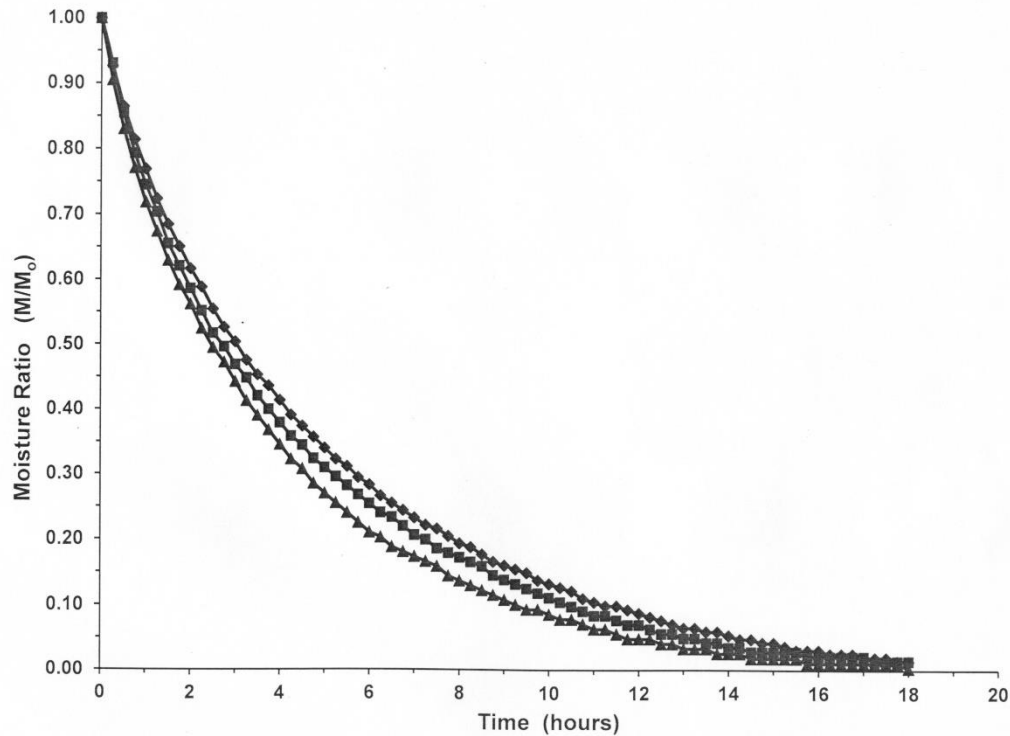

Figure 11-4: Moisture ratio versus time for three drying trials of quartered hot yellow peppers

The equation for the average of the three curves shown in Figure 11-4 can be obtained by plotting the average moisture ratio versus time. It can also be found reasonably accurately by taking the equations of the moisture ratio for the three curves and simply taking the average of the three rate constants in the exponents.

$$\begin{aligned} \text{Average} &= \frac{(-0.231 - 0.216 - 0.265)}{3} \\ &= -0.237 \end{aligned}$$

This gives the average equation:

$$y = e^{-0.237 t}$$

We now have an equation which offers a great deal of flexibility as a predictive tool for further drying runs for quartered

hot yellow peppers under the same drying conditions (i.e., 50°C and 0.5 metres per second airflow). All we need to know is the starting moisture content of the hot yellow peppers which we are going to cut into quarters and dry under these conditions and we should be able to obtain a reasonably accurate time to reach a specified final moisture, or calculate the moisture at a given time.

The following sample calculations will show how to do this.

Problem Statement:

Calculate the wet basis moisture of a sample of hot yellow peppers after 6.5 hours of drying at 50°C with an air velocity of 0.5 metres per second. The peppers are sliced into quarters lengthwise and have an initial moisture of 91.7% on a wet basis.

Solution:

It may be helpful to calculate the dry basis moisture first and get this calculation out of the way.

Based on 100 grams of material.

$$\begin{aligned} 91.7\% \text{ moisture} &= \frac{91.7 \text{ g water}}{8.3 \text{ g dry solids}} \\ &= 11.04 \text{ g water / g dry solids} \end{aligned}$$

From our previous work, we know that the drying of hot yellow peppers under these conditions is defined by the relationship:

$$y = e^{-0.237 t}$$

where y is the moisture ratio content of the peppers at time t (in hours).

We can now substitute 6.5 hours for “ t ” in this equation and calculate the corresponding value of y .

$$\begin{aligned} y &= e^{-0.237 \times 6.5} \\ &= e^{-1.5405} \\ &= 0.214 \end{aligned}$$

Since y is the moisture ratio, we know that the moisture after 6.5 hours of drying can be found based on the equation:

Moisture ratio

$$= \frac{\text{dry basis moisture at time } t}{\text{initial dry basis moisture}}$$

Rearranging this equation gives us the equation for the dry basis moisture, into which the appropriate known values can be substituted:

$$\begin{aligned} \text{Dry basis moisture at time } t &= \text{moisture ratio} \times \text{initial moisture} \\ &= 0.214 \times \frac{11.05 \text{ g water}}{\text{g dry solids}} \\ &= 2.365 \text{ g water / g dry solids} \end{aligned}$$

Wet basis moisture

$$\begin{aligned} &= \frac{\text{weight of water}}{\text{total weight}} \times 100\% \\ &= \frac{2.365 \text{ g water}}{3.365 \text{ g total}} \times 100\% \\ &= 70.28\% \approx 70.3\% \end{aligned}$$

Therefore, the moisture of the sample will be approximately 70.3% on a wet basis after 6.5 hours of drying.

Note: The total weight of 3.365 grams was found by taking 2.365 grams of water and adding them to the 1.000 grams of dry solids in which the water is contained.

It should also be noted that the equation we developed for drying the quartered hot yellow peppers should not be applied to samples with initial moisture contents that are substantially higher or lower than the samples used in the drying trials from which the equation was derived. Large variations in initial moisture may affect the drying kinetics from one sample to the next.

11.5 Curve Fitting Difficulties

In general, it is not terribly difficult to fit an equation to a curve using the features of a spreadsheet program. That being said, there are some problematic situations which can arise.

In most of the work being done to obtain information about the kinetics of drying, we would dry the material until most, if not all, of the water was removed and the final product was “bone dry”. While processors would not dry their products

to this degree, we need to follow the total removal of water in our trials to get a complete picture of what is happening.

Figure 11-5 shows the dry basis moisture content of the pepper slices for the full 24 hours of a particular run for quartered hot yellow peppers. This is actually one of the runs shown in Figure 11-3. The equation for the curve and its R-squared value as calculated by the spreadsheet program are included on the graph.

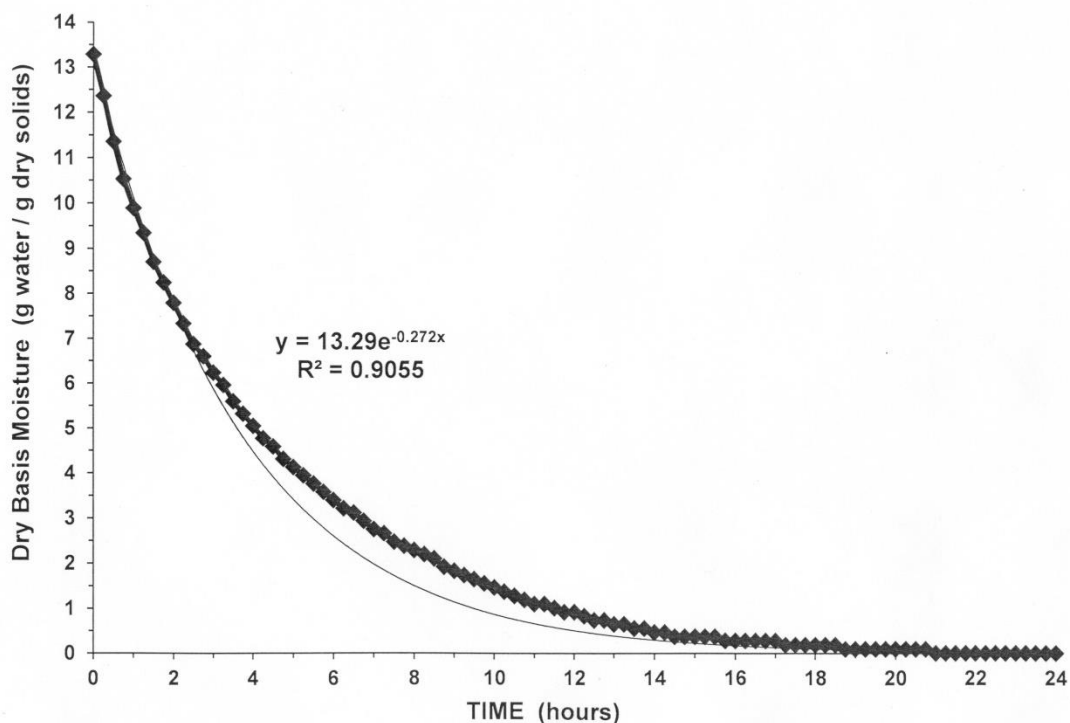

Figure 11-5: Curve fitting for 24 hours drying of quartered hot yellow peppers

Using the entire set of data for the full 24 hours during which the drying test was run in Figure 11-5, we obtain the following equation:

$$y = 13.29 e^{-0.272t} \quad R^2 = 0.9055$$

Please note that t has been substituted for x from the trend line equations to more clearly indicate that the variable in the exponent is time, expressed in hours.

The key to determining if this equation is a good representation of the experimental data is looking at the R-squared value for the data in Figure 11-5. It is only 0.9055 which tells us that the data do not fit the computer generated trend line very well.

The poor fit of the trend line giving us the equation of the drying curve can be seen where the trend line diverges from the experimental data curve. The trend line begins to drop below the experimental data curve at approximately two hours into the run and does not rejoin the experimental data curve until about 15 hours of drying. This evidence should indicate that we need to consider refining our treatment of the data in hope of obtaining a better fitting equation.

Figure 11-6 shows the same curve as presented in Figure 11-5. However, it uses only the first sixteen hours of drying data for setting up the mathematical equation of the drying process

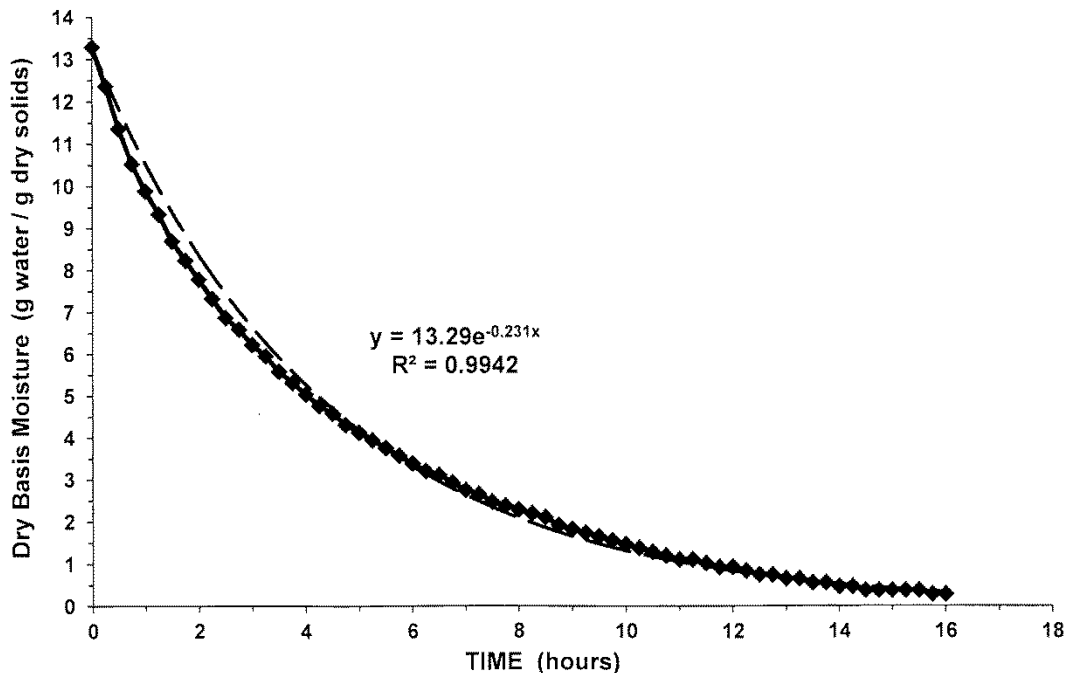

Figure 11-6: Curve fitting for 16 hours drying of quartered hot yellow peppers

From Figure 11-6, the following kinetic equation was obtained:

$$y = 13.29 e^{-0.231t} \quad R^2 = 0.9942$$

As can be seen from the R-squared value being very close to 1.000, the data fit this equation extremely well. The trend line in Figure 11-6 really only deviates from the actual data during the early stages of the drying process. In the overall scheme of things, this is not a serious problem since it is clear from the graph that by the time the dry basis moisture has begun to approach lower levels, the experimental data are following the trend line quite closely.

The value of the exponent is different in both treatments of the data in Figures 11-5 and 11-6. The value $-0.272t$ from Figure 11-5 indicates that the drying is proceeding faster than indicated by the exponent $-0.231t$ in Figure 11-6. From an application perspective, it would appear that the equation obtained from Figure 11-6 should provide more meaningful results. The question then arises as to why they are different.

Just as an aside, the curve for this run which was shown in Figure 14-3 was plotted for 18 hours instead of 16 hours. It gave the results:

$$y = 13.29 e^{-0.231t} \quad (R^2 = 0.9946)$$

which are differ from those obtained in Figure 11-6 only in the fourth decimal place of the R^2 value.

The reason for this difference is not really all that difficult to understand. After 16 hours, the dry basis moisture has stabilized to a low level. For the next 8 hours there is only a slight reduction in the dry basis moisture as

residual traces of moisture are slowly removed. With four data points per hour being plotted, these 32 extra data points between 16 hours and 24 hours have the effect of dragging the trend line downwards. This, in turn, affects how well the trend line fits the data in the earlier stages of drying. As previously stated, the trend line in Figure 11-5 falls below the data points from just after two hours of drying until almost fifteen hours of drying. If we were to use the equation of the trend line generated by Figure 11-5, there would be an erroneously low prediction of the dry basis moisture during the time we are trying to determine how far the drying process has proceeded.

The lesson to be learned here should be clear. Do not include excessive amounts of data after the moisture content of the product has stabilized in the mathematical modelling process. You should plot all the available data, but conduct multiple curve fittings for the trend line limiting the number of data points actually included in the modelling itself. Generally, you should not go much beyond the moisture level at which the drying process appears to stabilize.

In some cases, it may not be possible to get a good fit of a trend line to the experimental data using polynomial, linear, or logarithmic curves. Personal experience has shown that exponential curves tend to be applicable in most cases. Linear equations are ideal for the first few hours of drying when the material is going through its constant rate drying period. Polynomial curves may be confusing and can complicate the interpretation and comparison of data between one run and others where

exponential curves provide a suitable fit to the experimental data.

With increasing experience, you may find that you are able to model drying using a two-stage process where the earlier hours of drying are modelled with an equation which is separate from the equation used to model the final hours of drying. We will not worry too much about this here.

11.6 Creating and Using Moisture Ratio Mathematical Equations

Previously in this chapter, we showed how to compare drying curves for similar materials having different initial moistures using the concept of “moisture ratio”. Taking the dry basis moisture content at any time during the drying process and dividing it by the initial dry basis moisture provided a dimensionless value between zero and one.

Figure 11-6 gives us the water removal or drying equation for a specific test where quartered hot yellow peppers were dried. This equation was:

$$y = 13.29 e^{-0.231t}$$

Unfortunately, this equation is only applicable to pepper samples with an initial moisture content of 13.29 grams of water per gram of dry solids, or 93.0% wet basis moisture. It cannot be used in its current form for any other initial moisture content. This problem can be resolved using a “moisture ratio” approach.

Moisture ratio =

Dry basis moisture at time t
Initial dry basis moisture

If “y” is the dry basis moisture content at time “t”, we can get the moisture ratio by dividing the equation for y by the initial dry basis moisture. In our example, the initial dry basis moisture is 13.29 grams of water per gram of dry solids.

Moisture ratio =

$$\frac{y}{13.29} = \frac{13.29}{13.29} e^{-0.231t}$$

Moisture ratio = $e^{-0.231t}$

If M is the dry basis moisture at time t and M_0 is the initial dry basis moisture, we can re-write the equation for the moisture ratio as:

$$\frac{M}{M_0} = e^{-0.231t}$$

From which we can obtain:

$$M = M_0 e^{-0.231t}$$

This equation is now in the form that can be used to predict the dry basis moisture at any time t in the drying process for a hot yellow pepper cut into quarters and being dried at conditions identical to those used to create this mathematical equation or “model”. The only information required is the initial dry basis moisture of the quartered hot yellow pepper slices.

Suppose we have a hot yellow pepper with an initial moisture content of 91.9% wet basis and we want to find its moisture content after 7.5 hours of drying.

First, we need to calculate the initial dry basis moisture content. Based on 100 grams of material, it follows:

$$\begin{aligned} 91.9\% \text{ moisture} &= \frac{91.9 \text{ g water}}{8.1 \text{ g dry solids}} \\ &= 11.35 \text{ g water / g dry solids} \end{aligned}$$

Recalling our equation:

$$M = M_0 e^{-0.231t}$$

We can substitute the initial dry basis moisture for M_0 and 7.5 hours for "t" to get:

$$\begin{aligned} M &= 11.35 e^{-0.231 \times 7.5} \\ &= 11.35 e^{-1.7325} \\ &= 11.35 \times 0.1768 \\ &= 2.007 \end{aligned}$$

2.007 grams of water per gram of dry solids is the dry basis moisture at time $t = 7.5$ hours. Based upon the precision of our model, we would be wise to round this value to 2.0 grams of water per gram of dry solids; or, perhaps 2.01 grams of water per gram of dry solids.

The wet basis moisture at 7.5 hours will be:

$$\begin{aligned} \% \text{ moisture} &= \frac{2.007 \text{ g water}}{3.007 \text{ g total}} \times 100\% \\ &= 66.7\% \end{aligned}$$

For this calculation, we have used the actual value of the dry basis moisture content with its three decimal places obtained from the previous calculation step. The final answer can then be rounded off to be more realistic.

12: USING DRIED FRUITS AND VEGETABLES

12.1 Introduction:

Up to this point, we have been primarily concerned about removing moisture from fruits and vegetables. However, we should not lose sight of our ultimate objective – to use these dried materials in the preparation of meals at a later date.

12.2 Rehydration – Definition:

For our purposes, we will define “rehydration” simply as **the process of adding or putting moisture back into previously dried materials.**

12.3 Dried Foods as Snacks:

Perhaps the simplest way to consume dried foods is as snacks. Dried apple rings (see Figure 12-1) are sweet and chewy. They are light-weight and require no refrigeration, making them idea for transporting when weight and storage conditions are a problem.

Since almost all of the water is removed in preparing the apple rings, there will be considerably less moisture present than if the equivalent weight of a fresh apple was eaten. For this reason, it is necessary to maintain an adequate fluid intake when eating dehydrated snacks such as dried apple rings.

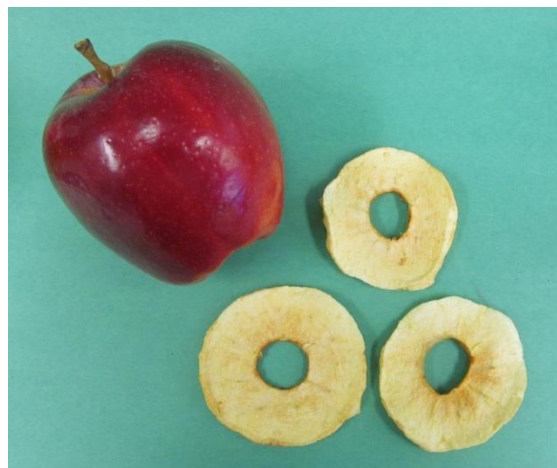

Figure 12-1: Dried apple rings

Chapter 12:
An Introduction to the Dehydration and
Drying of Fruits and Vegetables

Donald G. Mercer, Ph.D., P.Eng., FIAFoST
Department of Food Science
University of Guelph
Ontario, Canada
ISBN 978-0-88955-621-8
© 2014

12.4 Dried Foods in Cooking:

Almost without exception, when I ask people what they would like to dry, their first response is “tomatoes”.

Figures 12-2 and 12-3 show the differences in appearance between fresh and dried tomatoes.



Figure 12-2: Fresh tomato wedges in a tray dryer.



Figure 12-3: Dried tomato wedges in a tray dryer

Dried tomatoes lack the visual appeal of the fresh tomatoes and may not be suitable for use in salads and other applications where the soft, moist texture is desired. However, dried tomatoes are ideal for use in recipes for stews and other cooked dishes.

It should be kept in mind that fresh tomatoes may contain as much as 94% to 95% water compared to dried tomatoes which contain 10% water or less.

One kilogram (i.e., 1,000 grams) of fresh tomatoes with 95% moisture content will contain 950 grams of water and only 50 grams of dry solids. Using one kilogram of fresh tomatoes in a stew will contribute a significant amount of water to the mixture. 950 grams of water is just slightly less than one litre.

If we have dried tomatoes, 50 grams of dry solids will be present in about 55 or 56 grams of the dried material. When added to a stew, this weight of dried tomatoes will contribute only 5 or 6 grams of water.

As the pieces of dried tomato are boiled in the stew, they will absorb water in the process of rehydration. By drawing in moisture, the tomatoes will reduce the amount of water that is present in the liquid portion of the stew. For this reason extra water must be added to the stew to compensate for the moisture required to rehydrate the tomatoes.

Determining the exact amount of water to add may be a bit difficult. Instead, you may need to employ a method of trial and error. You can add some extra water when you begin to make the stew and then check the stew regularly as it cooks to see if more water is needed.

Some Internet sources recommend using two volumes of water to each volume of dry ingredient. Although this is not on a weight basis, it may provide a good starting point from which to work.

12.5 Rehydration of Dried Foods:

When preparing foods such as stews, dried ingredients can be rehydrated prior to being added to the mixture; or by being added to the mixture in their dry form.

If the dried ingredients are rehydrated before addition to the stew, it will not be necessary to make as great of an adjustment to the recipe as would be the case when the ingredients were added in their dry form. This is because the dried ingredients would use moisture from the entire mixture in their rehydration which would essentially reduce the amount of liquid broth present.

It is relatively easy to rehydrate ingredients prior to addition to a recipe, such as a stew. All you need to do is place the dried material in a pot or bowl and pour boiling water over it. After about twenty minutes, you should notice that the dried material has imbibed enough water to become plump or swollen and resemble its appearance prior to being dried.

When rehydrating dried material in this manner, you must be sure to have enough boiling water present to keep the material covered throughout the entire rehydration time. Again, we should be mindful of the guideline to use two volumes of boiling water per one volume of dried starting material. For example, if you have one cup of dried tomato slices, you would add two cups of boiling water.

It is important to stir the mixture regularly over the twenty minutes or so that it is soaking up moisture. You may also have to add more boiling water if

you see that the level of available water is getting a bit low in the pot or bowl.

A set of experiments was done in the lab to determine how much water was required to rehydrate a number of dried fruit and vegetable samples. A known weight of sample, with a measured starting moisture, was placed in a 400 mL beaker. 250 mL of boiling water were added and the mixture was stirred. The beaker and its contents were then placed in a boiling water bath to maintain the high temperature. Every five minutes, the mixture was stirred.

After twenty minutes, the mixture was given a final stir. The rehydrated contents of the beaker were then strained through a kitchen strainer to remove the excess water. The rehydrated sample in the strainer was tossed gently to remove any excess water caught between the pieces. No blotting was done to remove the surface water since this was found to actually squeeze moisture from the product. In a real-life application, the surface water would be incorporated into the final use of the rehydrated material as well.

The following photographs show the rehydration process for a sample of dried tomatoes. In Figure 12-4, we can see the dried tomato slices in a beaker prior to rehydration.



Figure 12-4: Dries tomato slices

After adding 250 mL of boiling water, the beakers were placed into a hot water bath to maintain the high temperature similar to that found in boiling stews etc. In the large pot shown in Figure 12-5, the temperature was above 95°C for the rehydration period. In this photograph, there are two beakers of tomatoes and two beakers of carrots. The beaker in the centre contains only water and was there to prevent the other four beakers from tipping over.



Figure 12-5: Rehydrating samples in a hot water bath

After 20 minutes of heating with regular stirring, the tomatoes appear as shown in Figure 12-6.



Figure 12-6: Rehydrated tomatoes

For completeness, the carrots being rehydrated in the bath in Figure 12-5 are shown in their dry form (Figure 12-7) and after rehydration (Figure 12-8).



Figure 12-7: Dry carrot slices



Figure 12-8: Rehydrated carrot slices

Table 12-1 lists the materials which were rehydrated in the lab. Their initial water content and final water content after rehydration are shown on both a wet and dry basis. Final moisture contents were calculated on the basis of the weight of the starting material, the initial moisture content, and the final weight of the material. It was assumed that no dry matter was lost in these tests. For comparison purposes, the wet and dry basis moistures for the fresh materials are included.

Table 12-1: Results of Laboratory Rehydration Experiments on Selected Dry Products

Material	Fresh Material		Dried Material		Rehydrated Material	
	Basis Moisture (%)	Dry Basis Moisture (*)	Wet Basis Moisture (%)	Dry Basis Moisture (*)	Wet Basis Moisture (%)	Dry Basis Moisture (*)
Apple Rings	85.6%	5.94	8.47%	0.093	79.0%	3.76
Beet Slices	86.9%	6.63	3.59%	0.037	66.2%	1.96
Carrot Slices	89.0%	8.09	4.22%	0.044	76.2%	3.21
Cassava - mashed	65.4%	1.88	4.80%	0.050	71.8%	2.54
Celery Pieces	95.5%	21.2	8.66%	0.095	81.1%	4.28
Hot Yellow Peppers	93.0%	13.3	7.31%	0.079	83.9%	5.22
Jalapeno Peppers	94.0%	15.7	11.01%	0.124	78.6%	3.68
Papaya Slices	86.9%	6.63	5.72%	0.061	77.5%	3.44
Radish Slices	95.2%	19.8	9.62%	0.106	84.7%	5.55
Scotch Bonnet Peppers	88.0%	7.33	8.64%	0.095	87.2%	6.79
Tomato Wedges	93.8%	15.1	4.89%	0.052	80.3%	4.08
Yams - mashed	69.2%	2.25	4.47%	0.047	78.1%	3.57

* the units of the dry basis moisture are “grams of water per gram of dry solids”

As can be seen in Table 12-1, none of the rehydrated materials (with the exception of the Scotch bonnet peppers and mashed cassava and yams) ever reached the moisture content it had when it was fresh. That being said, the moisture content of the rehydrated materials is quite satisfactory for use in various hot dishes. It should also be pointed out that there may be further moisture uptake during prolonged simmering or cooking.

Several additional sets of photographs are provided below to show the differences in the dried and rehydrated forms of beets (Figures 12-9 and 12-10), celery (Figures 12-11 and 12-12), hot yellow peppers (Figures 12-13 and 12-14), and Scotch bonnet peppers (Figure 12-15 and 12-16).

The rehydrated materials listed in Table 12-1 were not taste-tested. There is no real indication as to the level of retention of heat in the peppers since no trained panel was available to perform any meaningful taste comparisons between the fresh and rehydrated samples.



Figure 12-9: Dried beet slices



12-10: Rehydrated beet slices



Figure 12-11: Dried celery pieces



Figure 12-12: Rehydrated celery pieces



Figure 12-13: Dried hot yellow peppers



Figure 12-14: Rehydrated hot yellow peppers



Figure 12-15: Dried Scotch bonnet peppers



Figure 12-16: Rehydrated Scotch bonnet peppers

As can be seen from these photographs, the water uptake is sufficient to cause each dried product to swell substantially. The rehydration also creates a soft cooked texture suitable for use as an ingredient in various recipes.

12.6 Recipes Using Dried Ingredients:

I am most grateful to Mrs. Hazel Roberts, (Head of Department, Hospitality and Agriculture, Division of Technical and Vocational Education, St. Vincent and the Grenadines Community College) for providing a number of recipes using fresh and dried ingredients.

These recipes clearly show the modifications necessary to account for the differences in water content between using fresh and dried ingredients.

For the “Tomato Chicken Soup” recipe, when dried tomatoes are used, it is necessary to add two cups of boiling water that were not required when fresh tomatoes were used. It should also be noted that a smaller weight of dried tomatoes is used than of ripe tomatoes. There is also a soaking step that is not present when using ripe tomatoes.

When making “Sweet Cassava Dumplings” from dried cassava, an adjustment in the volume of dried cassava is made, along with an increase in the amount of water, compared to when freshly grated cassava is used. The increase in the volume of dried cassava accounts for the fact that it has a lower bulk density than freshly grated cassava.

Please see the following pages for the actual recipes.

Tomato Chicken Soup

**Courtesy of Mrs. Hazel Roberts
Head of Department
Hospitality and Agriculture
Division of Technical and Vocational Education
St. Vincent and the Grenadines Community College**

Ingredients:

1 lb ripe tomatoes
4 oz chicken (chopped into small pieces)
1 medium onion
2 sprigs chive
2 cloves garlic
2 sprigs celery or parsley
Pepper (optional)
Salt to taste
1 medium sized tannia finely chopped
4 cups water

Method:

Preparation time 1 hour

1. Chop tomatoes, seasonings
2. Put in stainless pot and add water. Cover closely
3. Simmer for 30-40 minutes. Swizzle (i.e., stir lightly)
4. Add chicken, tannia and salt to taste
5. Simmer again for 15 minutes, stirring constantly to prevent sticking. Check taste.
6. Serve hot.

Dried Tomato Chicken Soup

**Courtesy of Mrs. Hazel Roberts
Head of Department
Hospitality and Agriculture
Division of Technical and Vocational Education
St. Vincent and the Grenadines Community College**

Ingredients:

8 oz dried tomatoes
2 cups boiling water
4 oz chicken (chopped into small pieces)
1 medium onion
2 sprigs chive
2 cloves garlic
2 sprigs celery or parsley
Pepper (optional)
Salt to taste
1 medium sized tannia finely chopped
4 cups cold water

Method:

Preparation time 1 hour

1. Chop, seasonings finely
2. Put dried tomatoes in stainless pot and pour boiling water it, cover and leave to seep (soak) for 15 minutes
3. Add cold water to tomato. Cover closely
4. Simmer for 30-40 minutes. Swizzle (i.e., stir lightly)
5. Add chicken, tannia and salt to taste
6. Simmer again for 15 minutes, stirring constantly. Check taste.
7. Serve hot.

Sweet Cassava Dumplings

**Courtesy of Mrs. Hazel Roberts
Head of Department
Hospitality and Agriculture
Division of Technical and Vocational Education
St. Vincent and the Grenadines Community College**

Ingredients:

2 cups flour
1 ½ cup freshly grated sweet cassava
⅔ cup water
1 tsp baking powder (optional)
2 tsp brown sugar
1 tsp salt

Method:

Preparation time 45 minutes

1. In a mixing bowl add freshly grated cassava, salt and sugar.
2. Stir in Sifted flour and baking powder (optional).
3. Add water to make a firm but not soft dough.
4. Turn on a lightly floured board and knead lightly. Cover with a clean towel and rest for 2 minutes.
5. Cut into desired size and roll into balls, flattening the center.
6. Put into a sauce pan of boiling water 1 at a time.
7. Boil for 15-20 minutes.
8. Remove from sauce pan; serve as part of a main dish.

Dried Sweet Cassava Dumplings

**Courtesy of Mrs. Hazel Roberts
Head of Department
Hospitality and Agriculture
Division of Technical and Vocational Education
St. Vincent and the Grenadines Community College**

Ingredients:

2 cups flour
2 ½ cup dried sweet cassava
1 ⅔ cup water
1 tsp baking powder (optional)
2 tsp brown sugar
1 tsp salt

Method:

Preparation time 25 minutes

1. In a mixing bowl add freshly grated cassava, salt and sugar.
2. Stir in Sifted flour and baking powder (optional).
3. Add water to make a firm but not soft dough.
4. Turn on a lightly floured board and knead lightly. Cover with a clean towel and rest for 2 minutes.
5. Cut into desired size and roll into balls, flattening the center
6. Put into a sauce pan of boiling water 1 at a time.
7. Boil for 15-20 minutes.
8. Remove from sauce pan; serve as part of a main dish.

Tip: Dried Corn, coconut can be used to substitute for the cassava